

IP phone user manual

Document Version: V.3.2.0

Published: 2025-03-15

copyright

It shall not be used in any form or by any means (electronic, video, printed or otherwise) for commercial use, profit-making purposes. When this document is used for Internet distribution, the Company allows users to download or print it for private use.

warranties

The product specifications and inquiries mentioned in this manual are for reference only and are subject to update without notice. Unless otherwise agreed, this manual is intended only as a guide to use and provides the most accurate statements, information and advice possible, and makes no warranty, express or implied, as to what constitutes.

herald



This device complies with the essential requirements of CE, FCC and other relevant

CE

Marking

The device complies with the EU Safety Directive 2014/35/EU and the EMC Directive 2014/30/EU.

FCC Regulations Part 15

The equipment complies with Part 15 of the FCC regulations.

Operation should comply with the following two requirements

1. The device does not produce harmful interference.
2. The equipment must accept any interference received, including interference that may cause unintended operation.

WEEE Mark



Since there are certain hazardous substances in electronic products, in order to properly dispose of these electrical and electronic wastes and to recycle valuable resources, when users intend to dispose of this product, it should not be disposed of with other household wastes, but should be handled independently.

Customer Feedback

We are working hard to improve the quality of the documentation and would love to receive your feedback.

Purpose of preparation

Thank you for using IP Phones. The phone is a feature-rich simple office phone, in addition to high-definition sound quality, unique design, multi-language interchangeable; support for dual network ports, POE power supply; compatible with a number of vendors' service platforms, such as IPPBX, cloud PBX, IMS core network, softswitch, etc.; The detachable bracket can change to multiple views, 4 customizable function buttons and a friendly user interface to fully meet the needs of users to communicate and collaborate with .

The phone use the same firmware, the software functions are the same, the difference is in the hardware, the following table describes the difference between these hardware.

Product Model	clarification
IPhone N	regular version
IPhone (P/G/W/K)	P (carrying PoE power) G (carries Gigabit Ethernet port) W (with WIFI module) K (with external network port for expansion station)

This guide contains all the features of the phone and instructions to familiarize you with the features of the IP phone. Before installing the IP Phone, please read the following sections of this guide. [Safety Instructions](#) and [Packing List](#) sections of this guide for safe and quick use of the IP phone.

For more help, contact your network administrator or reseller.

Content of the manual

This guide contains the following:

- [I. Overview](#)
- [II. safe Notes on](#)
- [III. Phones Getting Started with](#)
- [IV. Telephone customization](#)
- [V. Basic functions](#)
- [VI. Advanced features](#)

catalogs

COPYRIGHT	2
WARRANTIES	2
HERALD	2
CE MARKING	2
FCC REGULATIONS PART 15.....	2
WEEE MARK.....	2
CUSTOMER FEEDBACK	2
PURPOSE OF PREPARATION	3
CONTENT OF THE MANUAL.....	4
CATALOGS	5
SUMMARIZE	9
HARDWARE COMPOSITION	9
DISPLAY ICON COMPOSITION.....	12
INDICATOR LIGHT DESCRIPTION.....	14
CONFIGURATION INTERFACE DESCRIPTION.....	15
<i>Phone Interface Configuration</i>	15
<i>Computer Web Configuration</i>	15
<i>Mobile Scanning Configuration</i>	16
USING DOCUMENTS.....	21
SAFE USE	22
GETTING STARTED WITH PHONES	24
PACKING LIST	24
PHONE INSTALLATION.....	26
<i>Mounting Base</i>	27
<i>Connection handle, headset (optional)</i>	28
<i>Connecting the power supply and network cable</i>	28
PHONE INITIALIZATION	30
PHONE STANDBY INTERFACE.....	31
CHECK THE STATUS OF YOUR PHONE	31
SETTING UP THE PHONE NETWORK	34
REGISTER FOR AN ACCOUNT	38
PHONE INPUT METHODS	39

PHONE CUSTOMIZATION	42
BASIC SETTINGS	42
<i>Multilingualism</i>	42
<i>Time & Date</i>	44
<i>Call-out button</i>	49
<i>Keypad lock</i>	50
<i>Power lamp</i>	53
<i>Backlight</i>	54
<i>Pop-up notification window</i>	55
<i>Boot Picture</i>	56
<i>Screensavers</i>	57
SOUND SETTINGS	58
<i>Volume settings</i>	58
<i>Ringtone Setting</i>	59
<i>Keypad tone</i>	60
<i>SMS alert tone</i>	61
<i>Signal tone</i>	62
<i>Sound Gain</i>	64
CONTACT MANAGEMENT	65
<i>local contact</i>	65
<i>Blacklists</i>	75
<i>LDAP Configuration</i>	78
CALL RECORD MANAGEMENT	82
REMOTE ADDRESS BOOK.....	85
UPDATE ADDRESS BOOK	87
ADDRESS BOOK SETTINGS	88
ACCESSORY CUSTOMIZATION	90
<i>Headset use</i>	90
<i>Extension desk</i>	92
SYSTEM CUSTOMIZATION	100
<i>Account Management</i>	100
<i>Programmable keys</i>	104
<i>Dialing Rules</i>	115
BASIC FUNCTIONS.....	125
MAKE A TELEPHONE CALL	126
ANSWER THE PHONE	129
END A CALL	129
REDIAL	130
DND.....	131
CALL TRANSFER.....	133
<i>Voluntary transfer</i>	134

<i>Automatic transfer</i>	134
CALL FORWARDING	139
<i>Blind transfer</i>	139
<i>Advisory Transfers</i>	141
CALL WAITING	142
PIN CALL.....	144
CALL HOLD.....	145
AUTOMATIC REDIAL.....	146
STATUS RETURN CODE.....	148
CALL COMPLETION.....	148
AUTO-ANSWER.....	149
ANONYMOUS CALL	150
HOTLINE.....	152
TWO-DIMENSIONAL BARCODE.....	154
CONFERENCE	155
UPDATE.....	157
UPLOAD RINGTONES.....	158
CAPTURE & DIAGNOSE.....	159
SCHEDULED RESET.....	160
CONFIGURATION MANAGEMENT	161
ADVANCED FEATURES.....	162
BLF (BUSY LAMP FIELD).....	162
<i>Configuring the BLF key</i>	162
<i>Using the BLF Function</i>	164
WALKIE-TALKIES	164
<i>Setting the intercom function buttons</i>	164
<i>Intercom function setting</i>	165
<i>Intercom function description</i>	166
MULTICAST	166
<i>Multicast Configuration</i>	167
<i>Multicast List Configuration</i>	168
<i>Accept multicast RTP streams</i>	171
<i>Multicast Usage</i>	172
<i>Message</i>	173
<i>Text message</i>	173
<i>Voicemail</i>	177
TR069	179
AUTOMATIC UPDATE	181
<i>Preparatory step</i>	181
<i>Automatic update procedure</i>	183
REMOTE CONTROL.....	185

SIP CONFIGURATION.....	188
<i>SIP Session Timer</i>	188
<i>Native SIP ports vs. TLS SIP ports</i>	189
ACTION URL.....	190
<i>Enables actions to be reported to the server</i>	190
<i>Description of variables</i>	193
<i>Web Configuration Instructions</i>	193
TYPE OF WEB ACCESS	194
TRUSTED CERTIFICATES	195

summarize

This section provides a brief overview of the IP Phones, with the following key points:

- [Hardware Composition](#)
- [Description of Display Icon](#)
- [Indicator light description](#)
- [Configuration Interface Description](#)
- [Using Documents](#)

Hardware Composition

The hardware components of the telephone mainly include the panel control panel, LCD display, call handles and external expansion disk. The details are shown in the figure below:

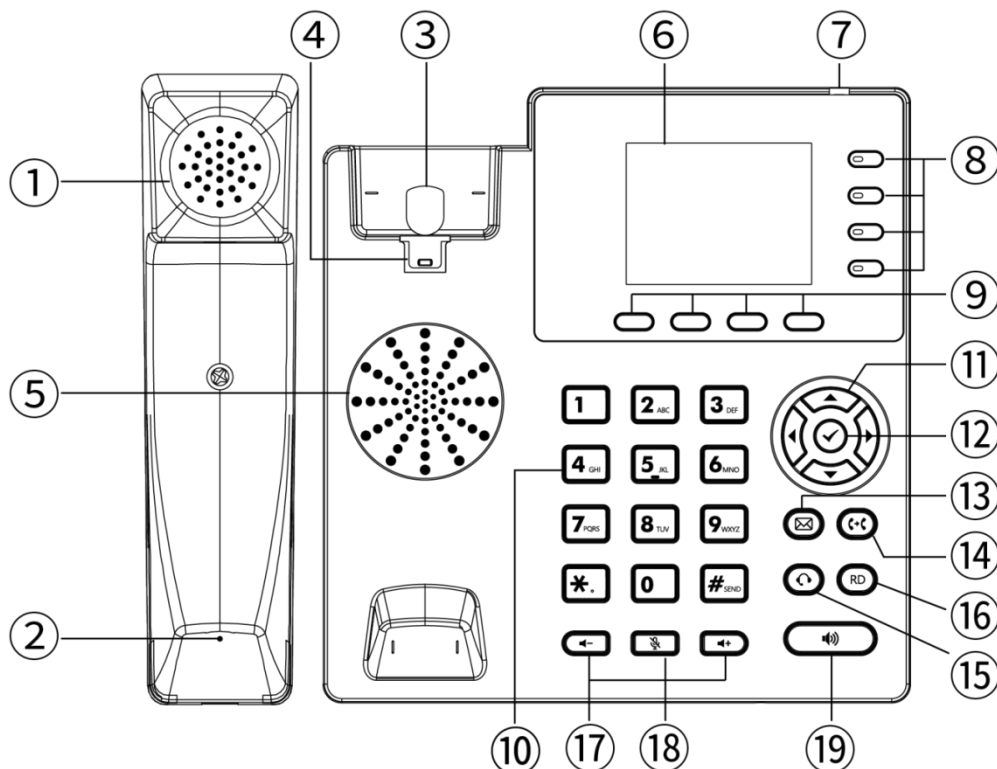





serial number	name	clarification
1	handpiece earpiece	Audio output when using the joystick for calls.
2	handheld microphone	Audio input when making a call using the joystick.
3	switch hook	Handle placed/fork spring pressed - call hangs up. Handle lifted/fork spring popped up - take off the machine.
4	Handle Hooks	Used to secure the handle. Hang the phone on the wall with the hook protruding upwards.
5	speakers	Outputs audio while the phone is on a hands-free call.
6	liquid crystal display	Displays information about the phone: - Register account information (display name, display number). - Time Date. - Tip Icons (see details) Display Icon Description). - Prompt messages (incoming calls, missed calls, e-mail messages). - Operational Cues.
7	Breathing light	- Incoming Call Alert Breathing Light" flashes fast. - The "Message Alert Breathing Light" flashes slowly. For details, please refer to Indicator light































		description .
8	Account key	<ul style="list-style-type: none"> - Switching accounts. - Intercom button. - Incoming caller ID call account light.
9	4 soft keys (below the display)	<p>Corresponds to the four function names at the bottom of the display</p> <p>(e.g., the default display of the 4 softkeys in the main screen is for the following functions: History, Directory, DND and Menu).</p> <p>These four softkeys change with the operation of the phone keys. In the function descriptions below, the softkeys referred to are these four keys, and the softkey functions correspond to the text at the bottom of the display.</p>
10	numeric keypad	Provides numeric input, upper and lower case letter input, punctuation input (* # . :).
11	Up, down, left and right buttons	Options for toggling the display.
12	 keystrokes	<ul style="list-style-type: none"> - Function setting confirmation operation. - Enter the number and dial. - Answer the call when it comes in. - View network status (IP address, MAC address, version information, etc.).
13	Message Button (old SMS) (Message)	Configure the message feature code, which is provided by each IPPBX, and press the number to quickly query the voice information of the phone after configuration.





14	Call Forwarding/Forwarding Button (Transfer)	<ul style="list-style-type: none"> - Blind transfer. - Inquiry transfer. - Quick-switch call forwarding when the phone is idle. <p>This can also be accomplished with the soft keys at the bottom of the screen.</p>
15	Headset buttons (Headset)	<p>Pressing the headset button causes the audio to go to the headset, which must be plugged in to use headset mode.</p> <p>For more information, please refer to Headset use .</p>
16	RD button (Redial)	For redialing.
17	Volume up and down buttons 	Provides 0~15 frame volume setting.
18	mute button (Mute)	Press the Mute button during a call to mute the call.
19	hands-free button (Speaker)	Use hands-free calling.

Display icon composition

The main icons used in the display and their corresponding descriptions are shown in the table below:

typology	Icon Style	Icon Description
Account (statistics) correlation		Account not enabled/not registered.
		Account registration in progress.
		Account is registered.
Voice status		Phones are free of interruptions.

		Auto-answer.
		Missed calls.
		Voice mail.
		Text message.
		The phone is in mute mode.
		Hands-free mode for calls.
		Call Handle Mode.
		Talking headset mode.
		Call mute.
		Call Forwarding Enabled.
Call record icon		Missed calls.
		Received call.
		Dialed number.
		Transferring calls.
System icon		The network is unavailable.
		Wifi icon when selected the base color turns red
		Advanced Settings icon when selected the base color turns red
		Function icon when selected the base color turns red
		CDR icon when selected the base color turns red
		Basic Settings icon select the base color to red
		Address Book icon when selected the base color turns red
		Message icon when selected the base color turns red
		Status icon when selected the base color turns red
		Keyboard lock enabled
Feature icon		DTMF
		XML browser
		XML group
		Hold
		Local group
		Message

		Intercom
		Callback
		Keypad lock
		Hot desking
		DND
		Prefix
		Fetch resident
		Group listening
		Group pickup
		Speed dial
		Call park
		Directory
		Voice mail
		Designated pickup
		Transfer
		Paging
		Multicast list

Indicator light description

The indicator status and description descriptions are shown in the table below:

typology	Indicator status	clarification
Breathing light (red light)	go out	Standby, power off.
	Ever Bright	The initialization indicator is always on when the phone starts up.
	flash	The indicator light flashes rapidly when the phone is ringing from an incoming call.
	slow flash	Indicator light blinks slowly when the phone receives message alerts such as voice mail, missed calls, etc.
Account line light (green light)	go out	The account is idle.
	Ever Bright	The account line is being occupied. The account line is on the line.
	flash	The line flashes rapidly when the phone is ringing

		from an incoming call.
--	--	------------------------

Configuration Interface Description

The phone supports the following ways to configure the phone:

- [Phone Interface Configuration](#)
- [Computer Web Configuration](#)
- [Mobile Scan Web Configuration](#)

Quickly configure the phone, through the phone LCD display and the phone keypad panel you can configure and use the phone functions. If you know the IP address of the phone, you can also enter the IP address of the phone into your browser to view all the features of the phone and configure them through your browser. If you don't have a computer nearby you can use your smartphone to scan the QR code provided by the phone to configure it. The details are described below:

Phone Interface Configuration

Enter the menu through the soft key of the phone, you can configure the basic settings (language, ringtone, etc.), and configure the advanced settings (account number, network, etc.), to enter the advanced settings you need to enter the administrator password, the initial administrator password of the phone is admin, input it and enter. Meanwhile, there are some basic functions in the menu, please check the introduction of specific function settings. [Function Configuration](#) section.

Computer Web Configuration

- **Method to view the IP address (IPv4 or IPv6) of the phone:**

It can be viewed in any of the following ways:

1. Press the  button to view.

2. Press the Menu soft key -> Enter Status Options to view.

Description IPv4 address e. g. 192.168.1.123.
IPv6 addresses such as 2003:4998:c:e33::1004 .

After obtaining the IP address of the phone, enter the IP address in the web browser of your computer, for example: IPv4 address (192.168.1.123 or <http://192.168.1.123>), IPv6 address ([\[2003:4998:c:e33::1004\]](http://[2003:4998:c:e33::1004]) or [http://\[2003:4998:c:e33::1004\]](http://[2003:4998:c:e33::1004])), enter the login page of the phone, use the login password to enter the main interface, the initial administrator account password are lowercase `admin.`, For the specific function settings, please refer to [Function Configuration](#) Chapter.

Mobile Scanning Configuration

Get the QR code of the phone through the QR code function of the phone, before scanning, the smartphone needs to be connected to the same network as the phone's WIFI, in order to use the smartphone to scan the QR code to access the phone's management page, the specific function setup introduction, please check the [Function Configuration](#) Chapter. For more help, please contact your network administrator.

A comparison of the features that can be configured on the three configuration method is shown below:

functional item	Phone Configuration	Web Configuration	Scanning Configuration
Status	✓	✓	✓
└ IPv4			
└ IPv6			
└ MAC address			
└ Uboot Version Number			
└ More			
└ Network			

└ Device			
└ Accounts			
└ WiFi(Only WiFi model)			
Account			
└ User information	√		
└ Label	√		
└ Display name	√		
└ User name	√		
└ Register name	√		
└ Password	√		
└ Domain name	×		
└ Server information			
└ Sip server 1	√		
└ Sip server 2	√		
└ Sip port number	√		
└ Transmission mode	√		
└ Re-registration times	×		
└ Server Expires	×		
└ Auto Answer	√		
└ Proxy Server	√		
└ NAT	√		
└ Codec Setting	√		
└ Account codec	√	√	√
└ IP direct dial codec	×		
└ Advanced			
└ DTMF	√		
└ User Agent	×		
└ SRTP	×		
└ RTP Port range	×		
└ Share line	×		
└ Mode of renewal	×		
└ Reliable transmission of temporary responses	×		
└ Caller ID field	×		
└ Session timer	×		
└ Session Heartbeat	×		
└ SIP Registration retry time	×		
└ Conference types	×		
└ Intercept feature code	×		
└ Unregister when restart	×		

└ RFC 2543 hold mode	×		
└ Synchronize server time	×		
└ is not registered for dialing	×		
└ Allows Contact to be overwritten	×		
└ Rtp Check	×		
Network setting			
└ Basic Setting			
└ IPv4/IPv6/IPv4 & IPv6	√		
└ DHCP	√		
└ Static IP	√		
└ Advanced Setting			
└ CDP & LLDP	√		
└ VLAN	√		
└ Voice Qos	×		
└ Web Server Type	√		
└ VPN			
└ OpenVPN	×		
└ L2TP	×		
└ Diagnosis		√	√
└ Pcap			
└ Normal Pcap	×		
└ Enhanced Pcap	×		
└ log			
└ local log	×		
└ Cloud log	×		
└ Diagnostics			
└ Ping	√		
└ Traceroute	√		
└ NAT			
└ STUN	×		
└ SNMP	×		
Features			
└ Call forward			
└ Always Forward	√	√	√
└ Busy Forward	√		
└ No Answer Forward	√		
└ Call transfer	√		

└ Auto Answer	√		
└ Anonymous Rejection	√		
└ Local Anonymous	√		
└ Hotline	√		
└ Call Hold			
└ Hold Tone	×		
└ Hold Tone Interval	×		
└ Call Number Filter	×		
└ QR code	√		
└ DND	√		
└ Call Waiting	√		
└ Psw Prefix	×		
└ Conference			
└ Local Conference	×		
└ Network Conference	×		
Advanced Features		√	√
└ BLF (Busy Lamp Field)	√		
└ Multicast	√		
└ Multicast Codec	×		
└ SMS			
└ Text Message	√		
└ Voice Mail	√		
└ Auto Redial	√		
└ Status Return Code	×		
└ Dual Headset	×		
└ Headset Prior	×		
└ Intercom	√		
└ Action URL	×		
└ Remote Control	×		
└ Auto Provision	√		
Customization		√	√
└ Sound			
└ Key Tone	√		
└ Ring	√		
└ SMS Beep	×		
└ Signal Tones	×		
└ Sound Gain	√		
└ Display			

└ Time&date	√		
└ Language	√		
└ Power LED	×		
└ Notification Popups	×		
└ Backlight	×		
└ BootUP Image	×		
└ ScreenSaver	×		
└ Power save mode	×		
└ Key As Send	√		
└ Dial Plan	×		
└ Dsskey			
└ LineKey	√		
└ Programmable Key	×		
└ EX Module	×		
└ Keypad Lock	√		
└ Auto Reboot	×		
└ Import/Export Configuration	×		
└ TR069	×		
└ SoftKey Layout	×		
└ SIP Setting	×		
Directory		√	√
└ Local Contacts	√		
└ Blacklist	√		
└ Remote Phone Book	×		
└ History	√		
└ Update Directory	×		
└ LDAP	×		
Security		√	√
└ Password	×		
└ Advanced setting password	√		
└ Trusted certificate	×		

Description Sweep Configuration and PC Web Configuration have the same functionality, the following chapters only show the diagrams for PC Web Configuration.

Using Documents

The phone is supplied with the following technical support manual:

name	clarification	Where to get	language type
Quick Start Manual	Includes easy installation and customization of the phone	Comes with phone package	Chinese/English
		official download	
IP Phone User's Guide	Detailed Functions and Usage	official download	Chinese/English

Safe Use

Please read the safety instructions carefully before installing and using the phone to ensure safe and convenient use of the phone!

- Use the power adapter specified for the product (included in the package). If you need to use a power adapter supplied by another manufacturer, please make sure that the voltage and current of the supplied adapter are in accordance with the specifications of the product (see details [Connecting the power supply and network cable](#)), and it is also recommended to use a product that has passed the safety certification, otherwise it may cause damage to the equipment or even result in fire or electric shock accidents. Before using this product, please check whether the power cord is damaged or not. Do not use damaged power cords and power cords in abnormal condition, such as twisted, stretched, or bundled power cords, as this may cause fire and electric shock accidents.
- Non-technical service personnel do not disassemble or repair the product by yourself, improper installation or repair may cause electric shock, fire and other accidents, while your product warranty will be invalidated, for technical support, please contact the agent or your network administrator.
- Maintain the temperature and humidity of the product to meet the working requirements of the product. Ensure that the product is placed flat on the working platform, and check that the anti-slip rubber on the base of the

product has not come off and caused the phone to slide on the platform.

Place the device away from electrical appliances with strong magnetic or electric fields, such as microwave ovens or refrigerators. Keep the device away from sources of ignition.

- Do not put metal foreign objects such as large pins, wires, etc. into the vents or crevices. Otherwise, it may cause electric shock and other injuries caused by the current passing through the metal foreign objects. If foreign objects or similar metal objects fall into the product, it should be stopped in time.
- This product contains small parts inside, place the device out of reach of children to avoid accidental swallowing of small parts.
- If you need to clean the phone, please cut off the power supply, use a dry rag to wipe, and after cleaning, place it in a ventilated place to dry naturally, the power adapter needs to be kept dry and clean, otherwise accidents may occur.

Getting Started with Phones





This chapter introduces you to the IP Phone, as follows:

- [Packing List](#)
- [Phone Installation](#)
- [Phone initialization](#)
- [Phone Standby Interface](#)
- [Check the status of your phone](#)
- [Setting up the phone network](#)
- [Register for an account](#)
- [Phone Input Methods and Input Methods](#)

Packing List

The following accessories are included in the shipping package of the IP Phone:

Accessory Name	quantities	photograph
IP Phone host	× 1	

IP Phone Handle	× 1	
IP Phone Base	× 1	
IP Phone Connection Cable	× 1	
Ethernet cable	× 1	

Power adapter (5.5mm DC plug 5V $\overline{\text{---}}$ 1A)	× 1	
Quick Start Guide	× 1	

Instruction Before installing the phone, please check the completeness of the accessories according to the packing list, if any accessories are missing, please contact your network administrator or seller.

Phone Installation

If you have already successfully installed the phone, skip this section and navigate to the [Initializing the Phone](#) section.

The installation steps are as follows:

- [Mounting Base](#)
- [Connection handle, headset \(optional\)](#)
- [Connecting the power supply and network cable](#)

Mounting Base

There are two types of base mounting:

- a) Desktop mounting
- b) Wall mounting

- Desktop mounting

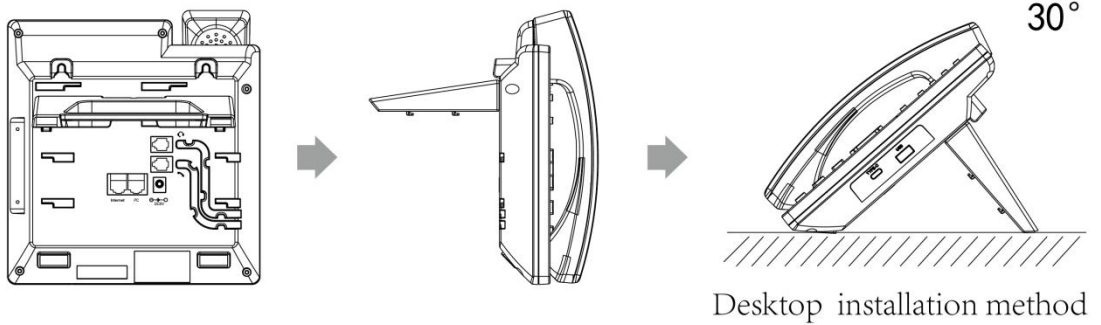
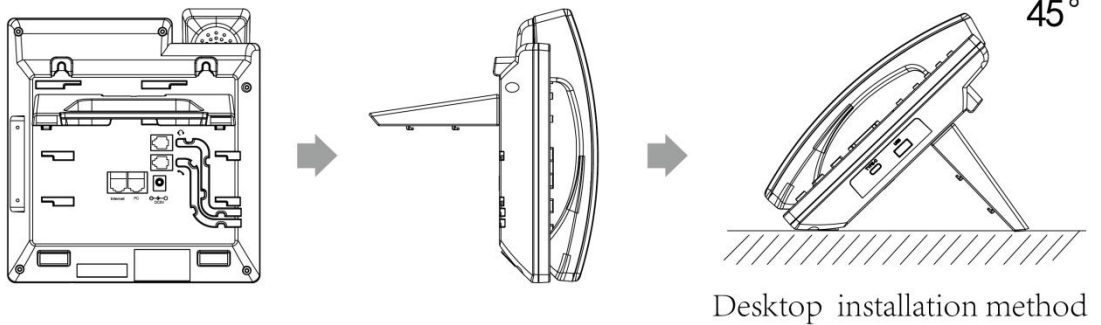

- Wall mounting

The hook of the phone for wall mounting requires reversing the handle hook to prevent the handle from falling off the phone.

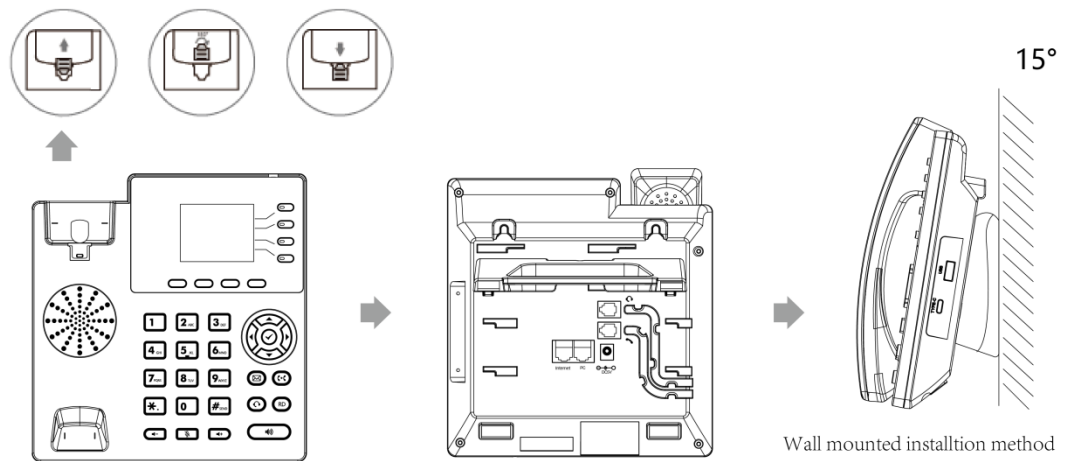

Connection handle, headset (optional)

Slot B is the grip jack and slot A is the headset jack .

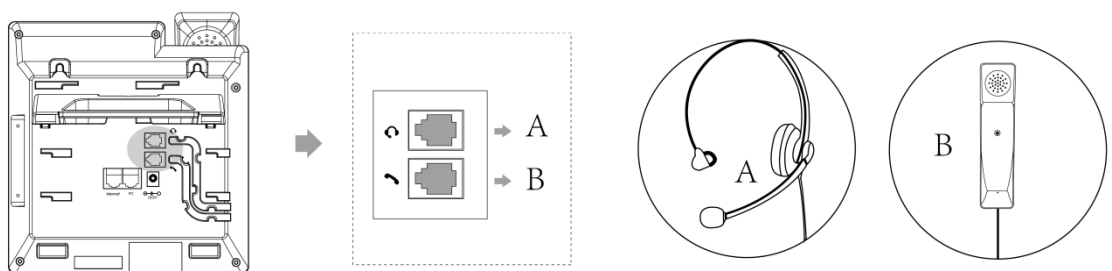

Instruction To use the headset, you need to turn on the headset mode, please check the details of how to use it. [Using the headset](#) section for details on how to use the headset.

Connecting the power supply and network cable

The phone supports two types of power supply:

- a) AC power supply
- b) POE power supply

- AC power

Use the power adapter included in the package to connect the power outlet to the DC5V socket of the phone; use the Ethernet cable included in the package or use a standard parallel cable to connect the upper layer switch/router to the Internet port on the back of the phone.

Instructions The voltage of the adapter used should not be higher than 5V \pm 1A to avoid damage to the phone chip. For safe use of the phone, please read the [Safe Use Instructions for](#) for safe use of the phone.

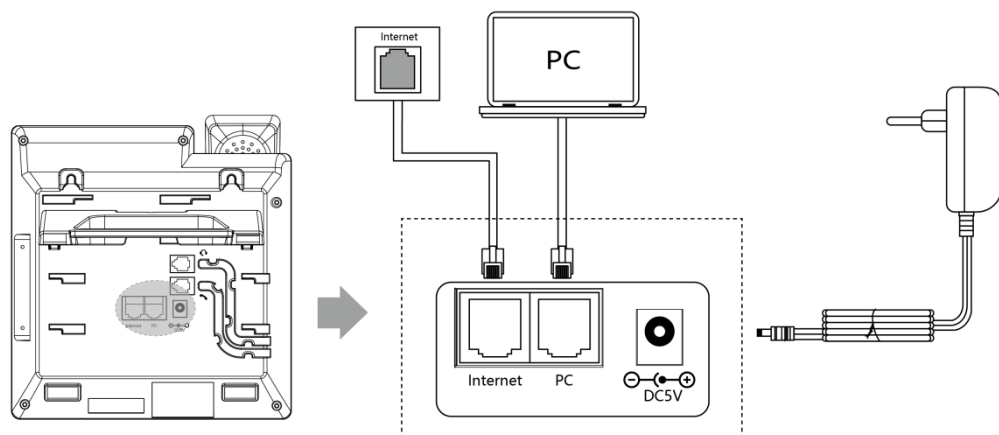

- PoE Power Supply

Use an Ethernet cable to connect a PoE switch to connect the hub to the Internet

Note: If you are using PoE power, please make sure your computer and switch support PoE power. If you use PoE power supply, you don't need to connect the adapter for power supply, if you need help, please contact your network administrator or reseller for confirmation.

port on the back of the IP Phones.

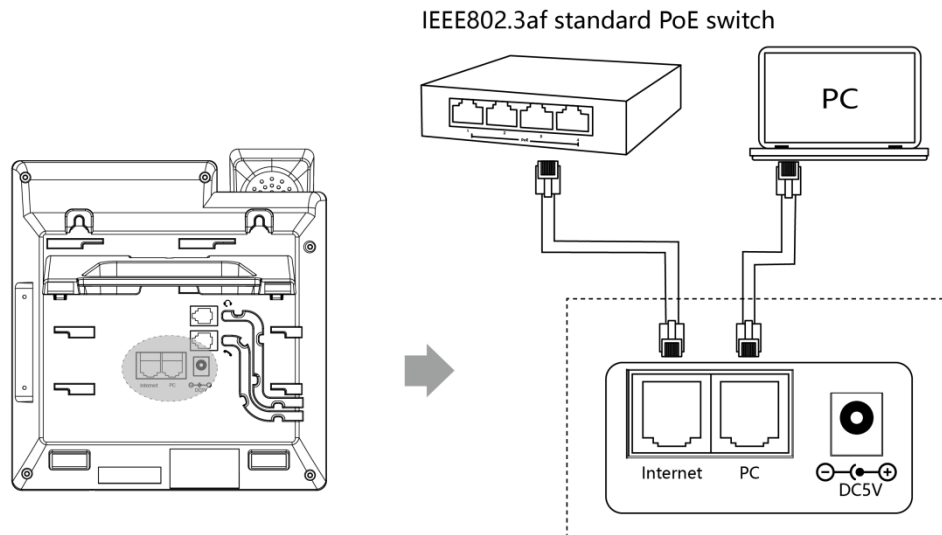

Phone initialization

When the phone is properly installed and powered up, the phone startup will make the following display:

- Phone initialization

The red breathing light is always on and the account soft key light is always on, the LCD screen displays "Welcome Initializing...". Please wait".

- Obtaining a network (the phone's initial network is automatically obtained by DHCP)

After successfully starting the phone, the phone will automatically obtain the assigned IP address, subnet mask, default gateway and DNS server and other network configurations. If the network cable is connected after the phone is started, the LCD display will show a prompt that the network is being obtained.

Description If you are unable to obtain network information, please check the [Network Settings](#) section, or contact your network administrator or dealer to check.

Phone Standby Interface

The display screen after the phone starts normally is as follows:

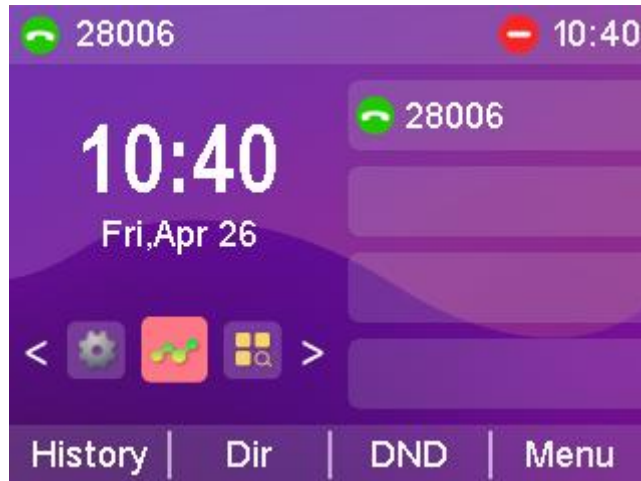

The phone standby screen displays the time and date of the phone, the status of the phone (Do Not Disturb), the registration status of the account, the extension number, labels, and labels for the four soft keys at the bottom of the LCD display (**History, Directory, DND, Menu**). For the icon descriptions of the standby screen, please refer to [Display Icon Composition](#) .

- The standby screen quickly jumps

1. Press the left and right keys to switch to the corresponding option. (You need to configure the left and right buttons of the programmable function keys to switch left and switch right.)

2. Press  shortcut key to enter the corresponding option list. (Configure the OK programmable function key to entering key)

For example, if you need to enable the auto answer function, you can press the left and right keys to switch to the function options, and press  to quickly jump to the function interface for configuration.



Check the status of your phone

The phone status contains the following information:

- network information
IP Mode, IPv4 / IPv6 Address, Subnet Mask, Default Gateway, DNS Servers.
- Account Status
SIP account registration information.
- Equipment Information
Firmware version, product name, hardware version, MAC address, product ID.

Viewing the status of the phone can be done in the following ways:

- Phone interface for viewing

1. Press the  button or press the softkey **Menu->Status** to access the view.
2. Press  or  to select up or down, and enter "More..." to see more detailed status.

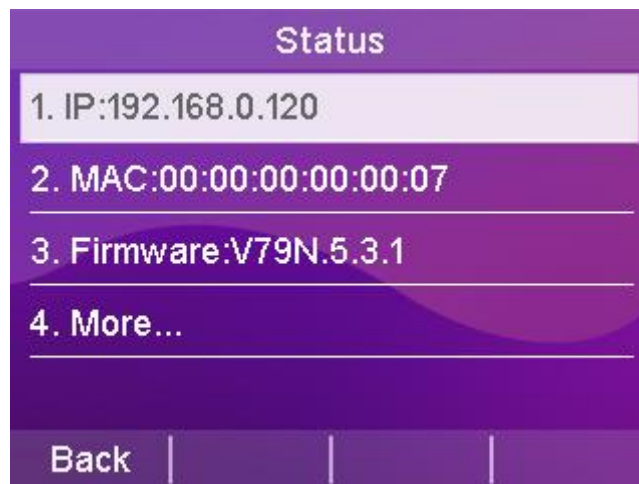

- Phone interface checking the wifi status

1. Press  button or press soft key **Menu->Status->More->Wifi** to view the detailed information.

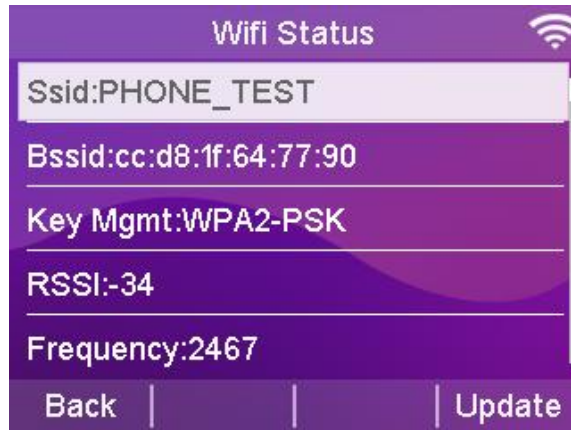

Ssid:Currently connected WiFi name;;

Bssid: Mac address;

Key Mgmt: Security type ;

RSSI: Signal strength (dBm) ;

Frequency: Frequency ;

- Check WiFi status on PC browser interface

- 1.Open the browser.
- 2.Click Status ->WiFi Status to view details.

Menu

- ☰ Status(S) ▲
- Status(a)
- WIFIStatus
- 👤 Account(A) ▼
- 🌐 Network(N) ▼
- 🖥️ DssKey(D) ▼
- ⚙️ Features(U) ▼
- ⚙️ Settings(E) ▼
- 📖 Directory(B) ▼
- 🛡️ Security(F) ▼

Status-WIFI Status

Wifi Status

WIFI Switch	On
MAC	54:89:07:9b:8a:0e
Connection Status	Connected
SSID	PHONE_TEST
RSSI	-34 dBm
BSSID	cc:d8:1f:64:77:90
Security Mode	WPA2-PSK
Security Type	CCMP
Frequency	2467 MHz

Network Info

IP Type	ipv4
---------	------

IPv4

IPv4 Config	DHCP
IP Address	192.168.17.47
Subnet Mask	255.255.255.0
Gateway	192.168.17.1
Primary DNS	221.6.4.66
Secondary DNS	58.240.57.33

[Refresh](#)

WiFi status: It displays WiFi status, connection status, SSID, signal strength, Bssid and other related information;

Network information: IPv4&IPv6 mode;

Details: Specific information about the network mode, including the type, address, mask, gateway, dns and other related information;

- Computer browser interface for viewing

1. Open your browser.
2. Enter the IP address (IPv4/IPv6) of the phone, such as 192.168.0.130 as shown above.



3. Enter the phone login page, enter the account password to login, the initial account password (admin/admin).

Explanation When you enter an IPv6 address, you must put brackets around the address, such as [fe80::daec:a3ff:fe43:ad34], otherwise you can't access the web page of the phone through the Ipv6 address, and not all servers support IPv6, so please consult with your network administrator before you use it.

Setting up the phone network

The IP Phone can be set up with three network modes: IPv4, IPv6, IPv4 and IPv6.



Description If there is no need to configure the network mode and the phone default IP mode is IPv4, skip this step.

- Setting the network mode through the handset interface

1. Press **Menu->Settings->Advanced Settings (password: admin)->Network->WAN Port.**

2. Press the **Toggle** softkey to select the desired mode (IPv4, IPv6, IPv4 and IPv6) in IP Mode.

3. In case of IPv4 and IPv6 modes, you can configure the mode priority, press

 or  to select the mode priority and press the **Toggle** soft key to switch.

4. Press the **Save** soft key to save after selecting the mode.

- Setting the network mode through the web interface

1. Log in to the phone page by IP address.

2. Click **Network Configuration (N)->Basic (b)->WAN Interface** and select it in the drop-down box.

3. Click the **Submit** button to save the configuration.

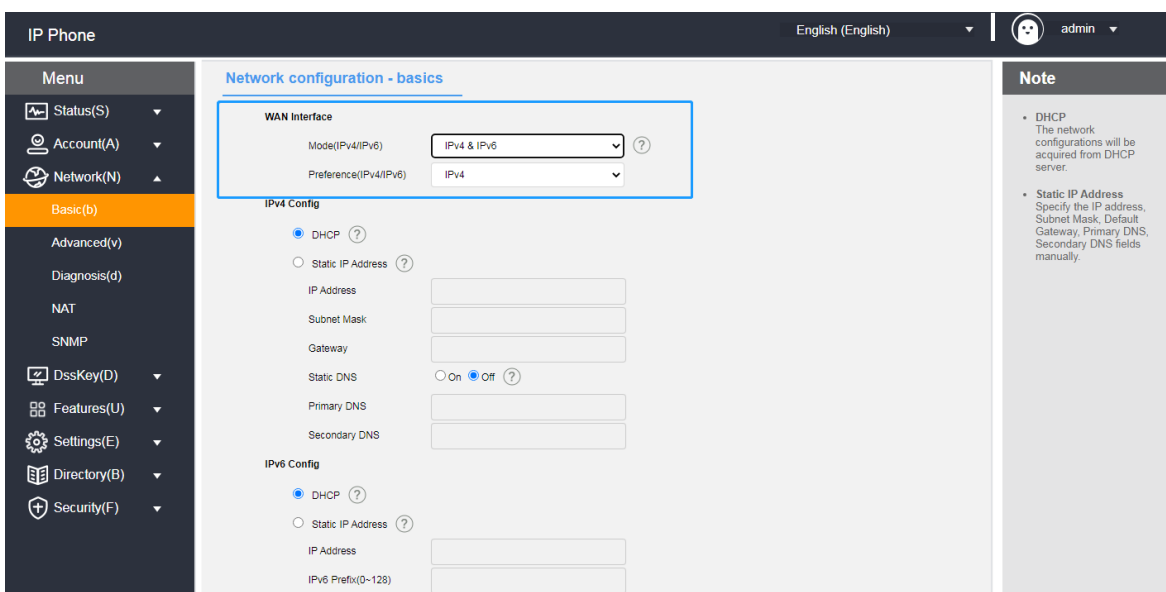





The screenshot displays the 'IP Phone' web interface. The top navigation bar includes 'English (English)' and 'admin'. A left sidebar menu lists various settings categories, with 'Basic(b)' highlighted. The main content area is titled 'Network configuration - basics' and features a 'WAN Interface' section. This section contains two dropdown menus: 'Mode(IPv4/IPv6)' set to 'IPv4 & IPv6' and 'Preference(IPv4/IPv6)' set to 'IPv4'. Below this, there are sections for 'IPv4 Config' and 'IPv6 Config', each with radio buttons for 'DHCP' (selected) and 'Static IP Address'. The 'Static IP Address' section includes input fields for IP Address, Subnet Mask, Gateway, Primary DNS, and Secondary DNS. A 'Note' panel on the right provides additional information about DHCP and Static IP Address configurations.

The phones can be set up with static IP addresses

- Setting up a static IP through the phone interface

1. Press **Menu->Settings->Advanced Settings** (password: admin)->**Network->WAN Port**.

2. Press  or  to select **IPv4** or **IPv6 -> Static IPv4 Client** and press the **Enter** softkey to **enter the** detailed settings.

3. Press  or  to select

IPv4 requires IP address, subnet mask, default gateway, preferred DNS and alternate DNS.

IPv6 requires IP address, IPv6 prefix, default gateway, preferred DNS and alternate DNS.

4. Press the **Save** soft key to save the configuration or the **Return** soft key to cancel the setting when you are done.

Static IPv4 Client	
1.Static IP:	192.168.100.3
2.Subnet Mask:	255.255.255.0
3.Default Gate...	192.168.100.1
4.Pri.DNS:	114.114.114.114
5.Sec.DNS:	
Back	123
Delete	Save

- Setting up a static IP through a web browser

1. Log in to the phone page by IP address.

2. Click **Network Configuration (N)->Basic (b)->IPv4 Configuration** or **IPv6 Configuration**.

3. Check the static IP address according to the selected WAN interface mode.

IPv4 requires IP address, subnet mask, default gateway, preferred DNS and alternate DNS.

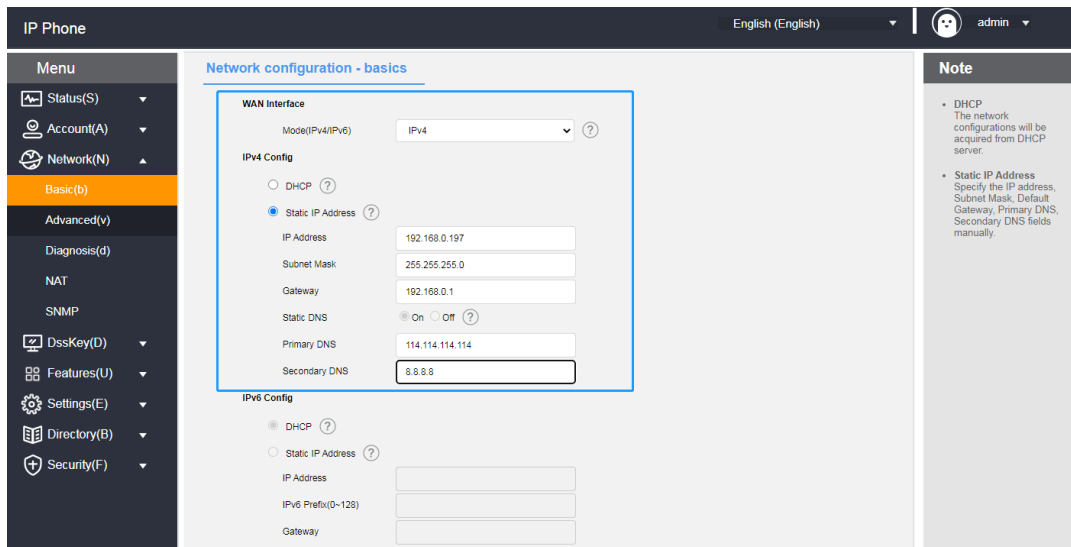

IPv6 requires IP address, IPv6 prefix, default gateway, preferred DNS and alternate DNS.

4. Click the **Submit** button to save.



- Set WiFi on the phone (only for WiFi model: T790PWN)

1. Press Menu->Settings-> Basic settings->WiFi->WiFi settings->WiFi switch to enable WiFi;

2. Press Menu->Settings-> Basic settings->WiFi->WiFi settings->>wireless network, After scanning, press  or  to select the WiFi you want to connect. Press **Options** -> **Configuration** and enter the password and then press Connect.

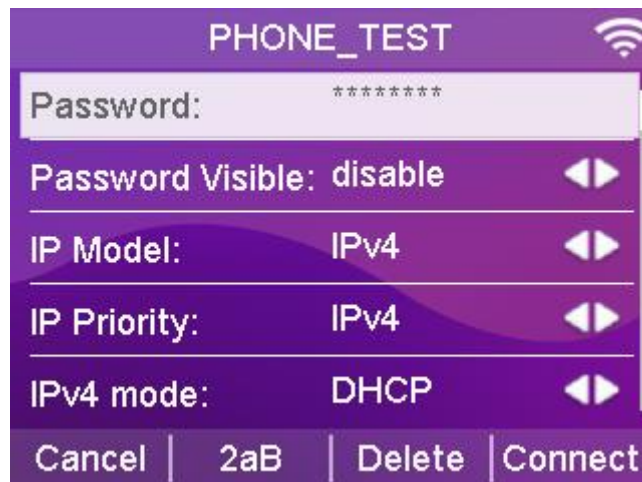

-Set WiFi through the web (only support WiFi phone models)

1. Log in to the web page through the IP address;

2. Click Network Settings ->WiFi.

The screenshot displays the 'Network configuration - WIFI' page. On the left is a dark sidebar menu with 'Wi-Fi' selected. The main content area is light gray and contains the following settings:

- WIFI:** Enabled (dropdown)
- Roaming enable:** Disabled (dropdown)
- Channel setting:** All (dropdown)
- Channel List:** (empty list)
- SSID 1:**
 - SSID: PHONE_TEST (text input)
 - Enabled: Enabled (dropdown)
- Security:**
 - Security Type: WPA PSK (dropdown)
 - Password: (masked text input)
- WAN Interface:**
 - IPv4/IPv6: IPv4 (dropdown)
- IP4 Config:**
 - DHCP
 - Static IP Address
 - IP Address: (text input)
 - Subnet Mask: (text input)
 - Gateway: (text input)
 - Static DNS: On Off
 - Primary DNS: (text input)
 - Secondary DNS: (text input)
- IPv6 Config:**
 - DHCP

3. Configure WiFi information as required;

WIFI: Enable/disable wifi status;

SSID: WiFi name;

Enable: Whether to enable this WiFi;

Security type: when there is no wifi password select none, normally select WPA PSK;

Password: WiFi password;

The address configuration can be configured according to the WiFi address pool. Non-professionals are advised to set as default, otherwise it may appear that the network cannot be connected.

4. Click Submit to save information.

Register for an account

The phone supports two types of configurations:

- Manual Configuration

- Software Batch Configuration

IP phone supports up to 4-account registration, account switching through the phone's account button, the phone is generally configured centrally by the

Explanation Wrong IP configuration may cause the phone can not access the web interface, before configuration, please make sure the IP address is not the same as the IP in the LAN, if you need help, please contact your network administrator.

system administrator, when you get the phone which has been configured account, as long as you plug in the Internet cable to get the IP and the account registration is successful, you can use the account to make a phone call. If the phone has not been configured with an account, you need to manually configure the account, for details, please refer to [Account Management](#) section.

Phone Input Methods

The phone supports keypad input, using the numeric keypad you can enter data into the screen to configure the phone's functions.





It supports four input methods: 123, abc, ABC and 2aB, where you need to enter data, use the soft keys to switch between these four input methods, when the input method is in 2aB, press the key repeatedly to switch between the characters you want to enter (numbers/letters/punctuation), when switching to the character you want to enter, stop and wait for 1 second before entering the next character.



- The characters that can be entered by different input methods of the keyboard are listed in the table below:

input method \ keystrokes	123	2aB	abc	ABC
	1	1		

	2	2abcABC	abc2	ABC2
	3	3defDEF	def3	DEF3
	4	4ghiGHI	ghi4	GHI4
	5	5jklJKL	jkl5	JKL5
	6	6mnoMNO	mno6	MNO6
	7	7pqrsPQRS	pqrs7	PQRS7
	8	8tuvTUV	tuv8	TUV8
	9	9wxyzWXYZ	wxyz9	WXYZ9
	0	0	Space	Space
	*	*.'#!?!\-()\$@/_	*.'#!?!\-()\$@/_	*.'#!?!\-()\$@/_
	  			
				
				

- Input Method Introduction:

(for) instance	way
Input English words	- Switch input method to 2aB
Switch	<ol style="list-style-type: none"> 1. Press the key  continuously until S appears. 2. Press the key  continuously until w appears. 3. Press the key  continuously until i appears. 4. Press the key  continuously until t appears. 5. Press the key  continuously until c

	<p>appears.</p> <p>6. Press the key  continuously until h appears.</p> <p>Finally form the word.</p>
<p>Enter IP address</p> <p>192.168.0.1</p>	<p>- Switch the input method to 123</p> <p>1. Enter the number.</p> <p>2. Press the key  consecutively The symbol '.' appears. .</p>

Phone customization

You can customize the phone according to your own habits, such as: language, time & date, ringtones, contacts, and lists, etc. This chapter will give a detailed introduction to customize the phone, the main contents are as follows:

- [Basic settings](#)
- [Sound Settings](#)
- [Contact Management](#)
- [Billing Management](#)
- [Accessory Customization](#)
- [System Customization](#)

Basic settings

The basic setup consists of the following:



- [multilingualism](#)
- [Time & Date](#)
- [call-out button](#)
- [keypad lock](#)
- [power lamp \(of an appliance etc\)](#)
- [backlight](#)
- [pop-up notification window](#)
- [Boot Picture](#)
- [screensavers](#)

Multilingualism

It supports multi-language, the default language of the initialization of the phone is English, and the phone interface and web interface are integrated: after changing the language of the phone, the web page will update the language synchronously with the phone after refreshing; after changing the language of the web interface,

you need to restart the phone.

- Setting the language through the phone interface

1. Press **Menu->Settings->Basic Settings->Language**.
2. Press  or  to select the language you want to change.
3. Press the **Save** soft key to save the language selected by the arrow as shown

below.



- Setting

the language

Description When you change the language in the phone interface, the language of the web interface will be changed to the language set by the phone after it is refreshed (e.g., if you set English in the phone interface and the web interface is refreshed, the language of the web interface will also be changed to English).

through the web interface

1. Enter the IP address of the phone to enter the web interface.

2. At the top right of the web interface, switch languages by using the drop-

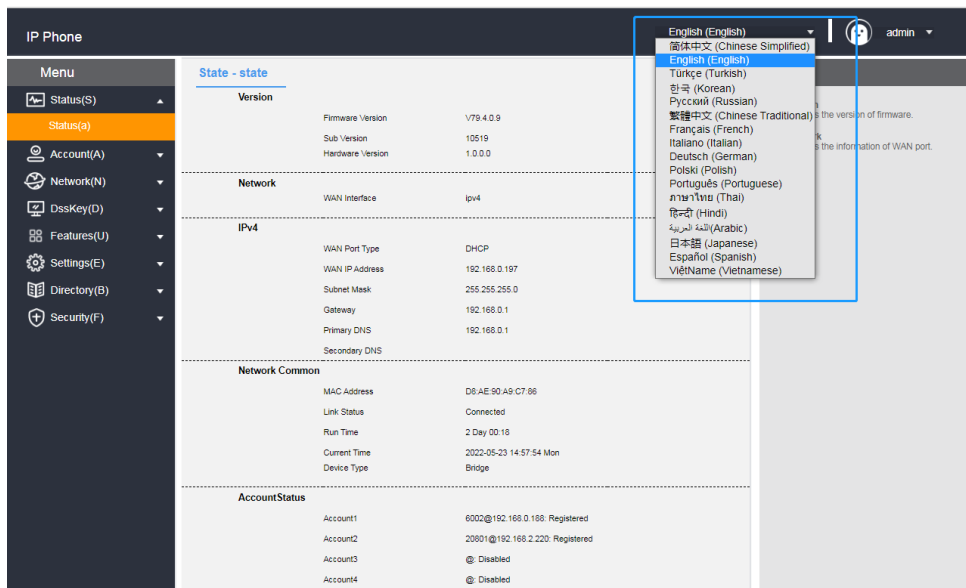

down box.

Explanation When you change the language in the web interface, the language of the phone interface will be synchronized to the language set in the web interface only when the phone is restarted (e.g., if you set English in the web interface and the phone is restarted, the language of the phone interface will also be changed to English).

Time & Date



The phone can be set to display the time on the LCD display when the phone is on standby, configure your NTP server to get the time and date automatically, or set the time and date manually.

- Automatic time and date acquisition through the phone interface

1. Press **Menu->Setup->Basic Settings->Time and Date->Automatic Timing**.
2. Press the **OK** soft key to save .

- Manually set the time and date through the handset interface

1. Press **Menu->Setup->Basic Settings->Time and Date->Manual Time Setting**.

2. Press  or  to select.
3. Enter the time and date you want to set via the numeric keypad.
4. Press the **OK** soft key to save the settings when they are complete.



- Automatically obtaining time through web browsers

1. Log in to the phone page by IP address.
2. Press **Setup (E) -> Date Time (t)**.
3. Manual settings are disabled by default.
4. Preferred server and alternate server fill in the NTP server address.
5. Set the synchronization period in (seconds).
6. Click the **Submit** button to save the settings when they are complete.

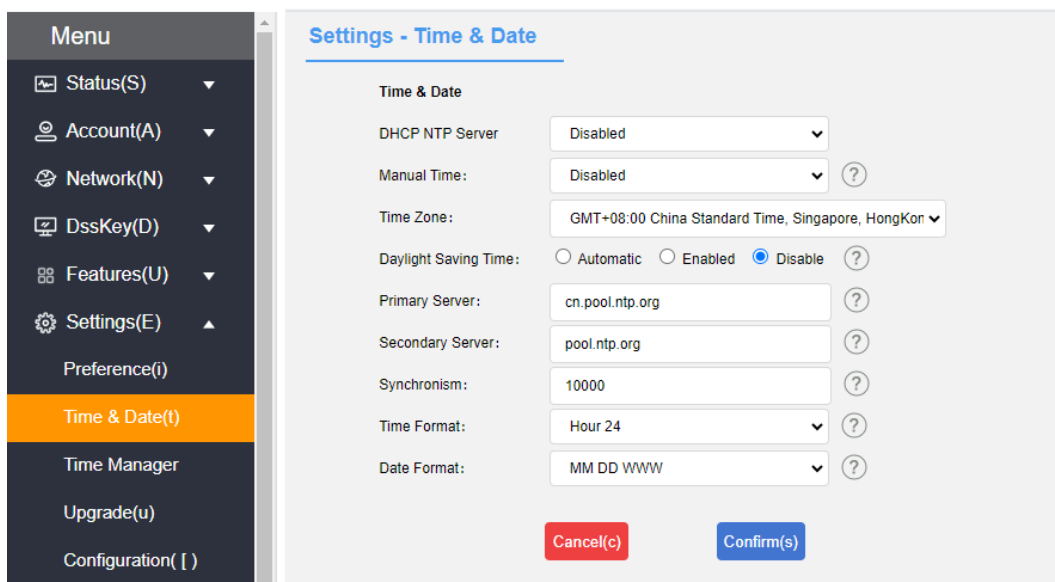

- Manual time setting via web browser

1. Log in to the phone page by IP address .
2. Press **Setup (E)** -> **Date Time (t)**.
3. Manual setting is selected as Enable.
4. Set the time and date as needed.
5. Click the **Submit** button to save the settings when they are complete.

The screenshot displays the 'Settings - Time & Date' configuration page. On the left, a dark sidebar menu contains options: Status(S), Account(A), Network(N), DssKey(D), Features(U), Settings(E), Preference(i), Time & Date(t) (highlighted in orange), and Time Manager. The main content area is titled 'Settings - Time & Date' and includes the following fields:

- Time & Date** (Section Header)
- DHCP NTP Server**: Disabled (dropdown)
- Manual Time**: Enabled (dropdown with a help icon)
- Date**: Year 2025, Month 3, Day 15
- Time**: Hour 15, Minute 41, Second 53
- Time Format**: Hour 24 (dropdown with a help icon)
- Date Format**: MM DD WWW (dropdown with a help icon)

At the bottom of the settings area, there are two buttons: a red 'Cancel(c)' button and a blue 'Confirm(s)' button.

- Daylight Saving Time (Daylight Saving Time)

1. Log in to the phone page by IP address .
2. Press **Setup (E)** -> **Date Time (t)**.
3. Daylight saving time is set automatically, just select the corresponding location.
4. The manual setting method of daylight saving time can divided into weekly and date methods. You should set the start time and end time of Daylight Saving Time.
5. Click the **Submit** button to save the settings when they are complete.

- ◆ Automatically sets daylight saving time:

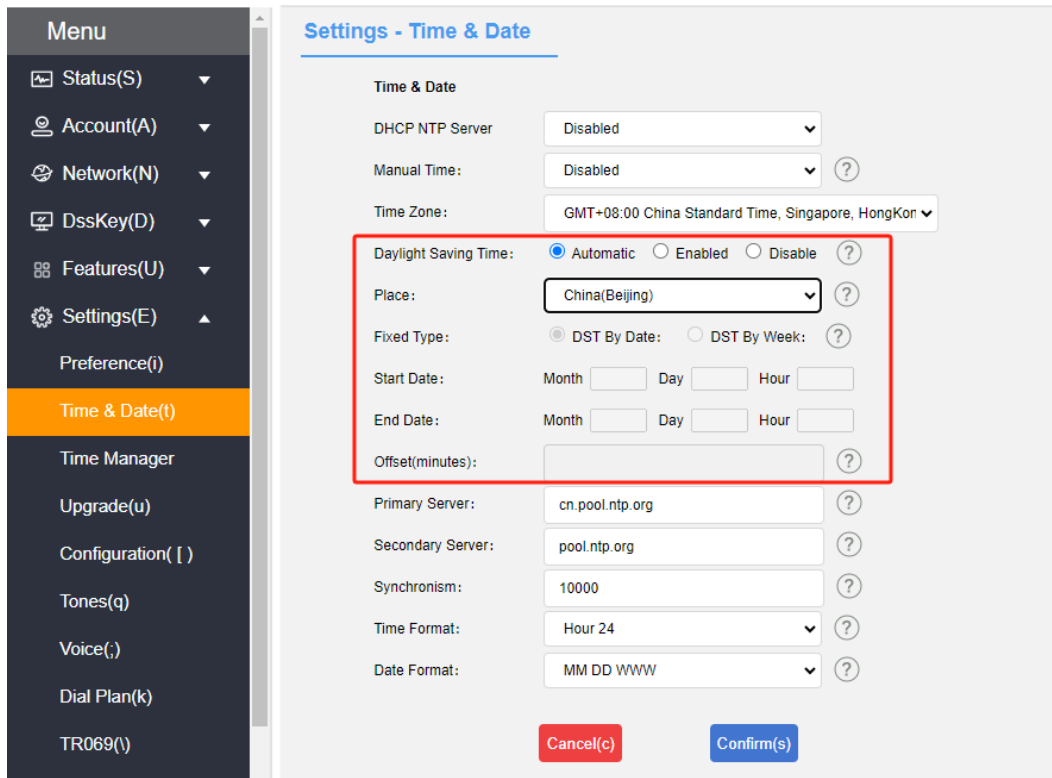

◆ The date method sets daylight saving time:

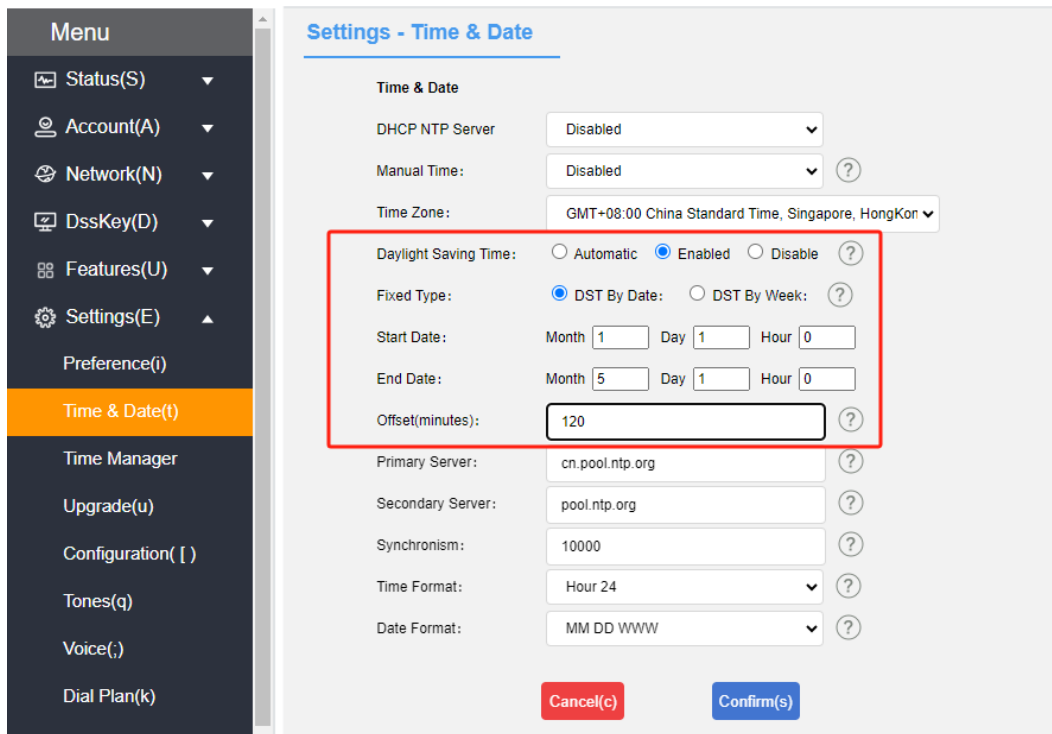

◆ Weekly way to set daylight saving time:

Menu

- Status(S)
- Account(A)
- Network(N)
- DssKey(D)
- Features(U)
- Settings(E)
- Preference(i)
- Time & Date(t)**
- Time Manager
- Upgrade(u)
- Configuration([)
- Tones(q)
- Voice(,)
- Dial Plan(k)

Settings - Time & Date

Time & Date

DHCP NTP Server: Disabled

Manual Time: Disabled

Time Zone: GMT+08:00 China Standard Time, Singapore, HongKor

Daylight Saving Time: Automatic Enabled Disable

Fixed Type: DST By Date: DST By Week

Start Date: January First In Month Sun 00:00

End Date: May First In Month Sun 00:00

Offset(minutes): 120

Primary Server: cn.pool.ntp.org

Secondary Server: pool.ntp.org

Synchronism: 10000

Time Format: Hour 24

Date Format: MM DD WWW

Cancel(c) Confirm(s)

- Setting the time and date display format through a web browser

1. Login to the phone page by IP address .
2. Press **Setup (E) -> Date Time (t)**.
3. Select the corresponding format in the time format (12-hour and 24-hour systems are supported).
4. The phone supports 7 date formats, different date formats will show the corresponding date on the LCD display of the phone.

The following table shows the dates displayed for each date format:

date format	The display shows
MM DD WWWW	Tuesday, April 7
YY MM DD	20-04-07
YYYYY MM DD	2020-04-07
YYYYY/MM/DD	2020/04/07
YY/MM/DD	20/04/07
YYYYY MM DD	April 7, 2020
MM DD WW	Tuesday, April 7

- Configure the DHCP NTP time on the web page

1. Log in to the phone page using the IP address.
2. Press Settings (E) -> Date Time (t).
3. Enable the DHCP NTP server.
4. Click Submit to save the configuration. You can synchronize the DHCP NTP server time and use the DHCP server on the internal network without connecting to the Internet.

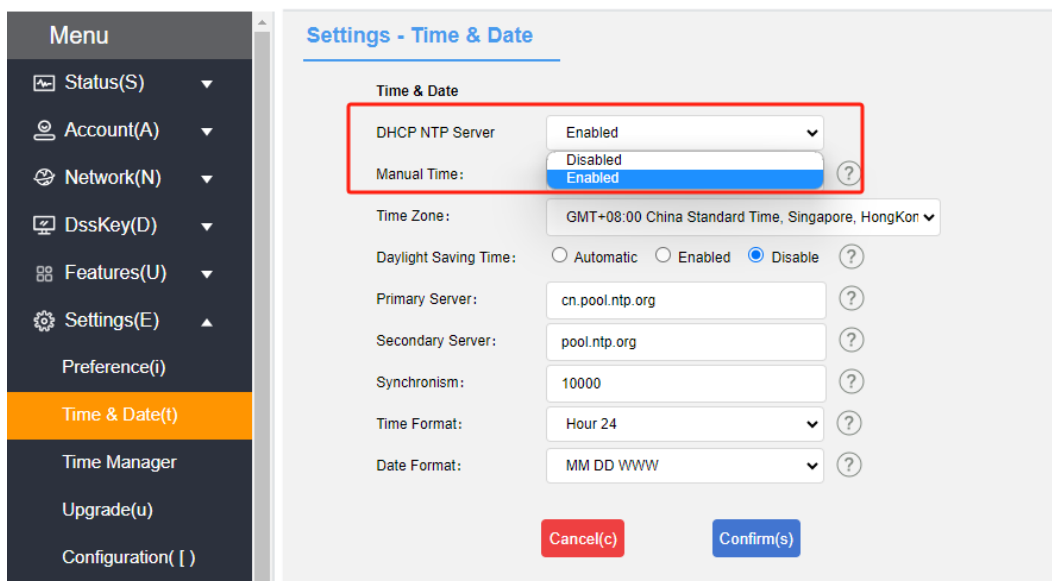

- Synchronization of server time via web configuration

1. Log in to the phone page by IP address .
2. Press **Account (A)** -> **Advanced (j)**.
3. Select Synchronize server time.
4. Click Submit to save the configuration, you can realize the synchronization of SIP server time, which can be used in the case of invalid ntp server.

Call-out button

The phone can be set up with the * and # symbols as call-out buttons, or you can use the  button, **dialing** softkeys for call-outs, depending on your personal habits.

- Setting the call-out key in the phone interface

1. Press **Menu->Features->Callout key**.
2. Use the **Toggle** soft key to toggle the callout key (*, #, disable).
3. Press the **Save** soft key to save the operation after switching.

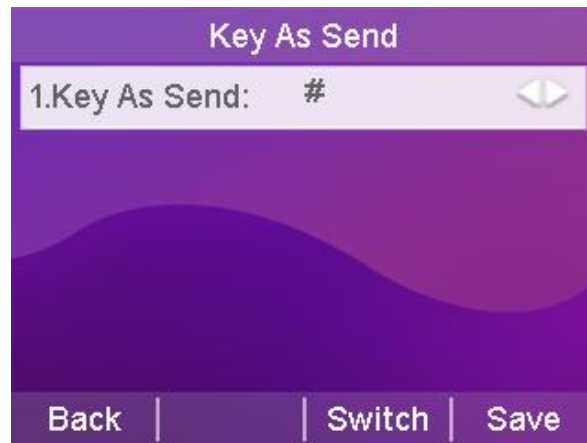

Description For details on how to make a phone call, please see [Dialing a Phone Number](#) section.

Keypad lock

Enabling keypad lock on the phone prevents the phone from being used by unauthorized personnel or accidentally operated due to misuse. Only emergency numbers can be dialed while the keypad is locked; unlocking the keypad is required to dial other numbers.

Keypad locks can be categorized by type: menu keys, function keys, and all keys.

Menu Key: The menu soft keys and programming keys set to menu are locked, all other keys are available.

Function keys: Direction navigation key, OK key, Message key, Transfer key, Redial key, 4 soft keys and other keys are locked. Other keys work normally.

All keys: except * key, # key, numeric keypad, speaker phone key, account key, and volume adjustment key, all keys are locked. The dialing screen can only dial emergency numbers with preset values. Incoming calls can be answered by lifting the handle, the Handsfree key, the Headset key, the Answer soft key, and the corresponding account number key. Calls can be rejected with the Reject soft key.

- Setting the keypad lock through the handset interface

1. Press **Menu -> Settings -> Basic Settings -> Keyboard Lock**.
2. Enter the keypad lock password (factory default password is admin) at the Unlock PIN and press the **OK** soft key to enter.
3. If you enter the default password, you will be prompted to change the password, which is used to enter the keypad lock settings and unlock the keypad.
4. The Enable Keyboard Lock option can be enabled by pressing the **left or right** button or **toggling the soft key**.

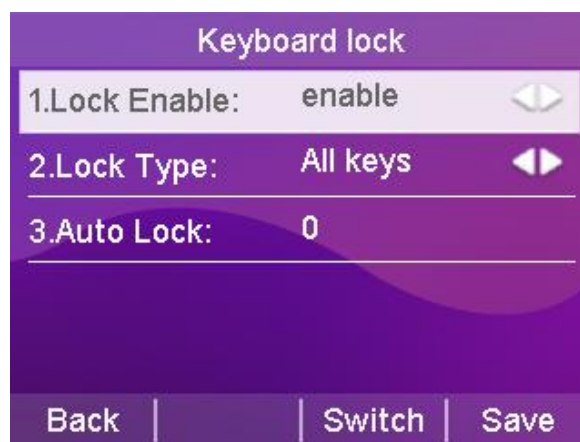

5. Press the **left or right** button or **toggle the** softkey to select the type of keypad lock at the Lock Type option.
6. Enter the auto-lock time (0 to 3600 seconds) in the keypad lock time input box
 - a.If the setting time is 0 seconds, the keypad lock will not be locked automatically after saving the keypad lock, you need to long press  to enable the keypad lock.
 - b. Set another time (e.g., set 10 seconds), then the phone will be on lock after the set time (e.g., 10 seconds) in the standby state.
7. Press the **Save** soft key to save the settings.

When the keypad lock is in effect, the handset LCD display will indicate that the keypad is locked. At the same time, the softkeys change to Emergency (for emergency calls) and Unlock (for unlocking the keypad lock). This is shown in the figure below

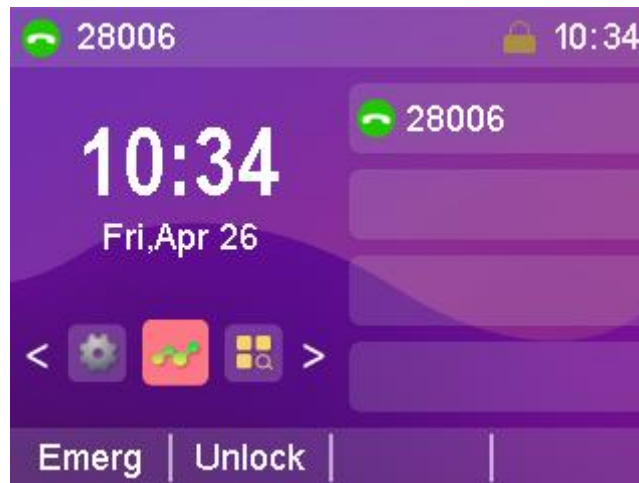

- Setting the keyboard lock through the web interface

1. Log in to the phone page by IP address.
2. Press **Function (U) -> Keypad Lock (=)**.
3. Enable keyboard lock.
4. Select the keypad lock type.
5. To change the unlock code set the unlock code.
6. Enter the automatic lock time (0~3600 seconds) in the keypad lock time input box.

a. If the setting time is 0 seconds, the keypad lock will not be locked

automatically after saving the keypad lock, you need to long press  to enable the keypad lock.

b. Set another time (e.g., set 10 seconds), then the phone will be locked after the set time (e.g., 10 seconds) in the standby state.

7. Set the emergency call number.
8. Submit for save operation.

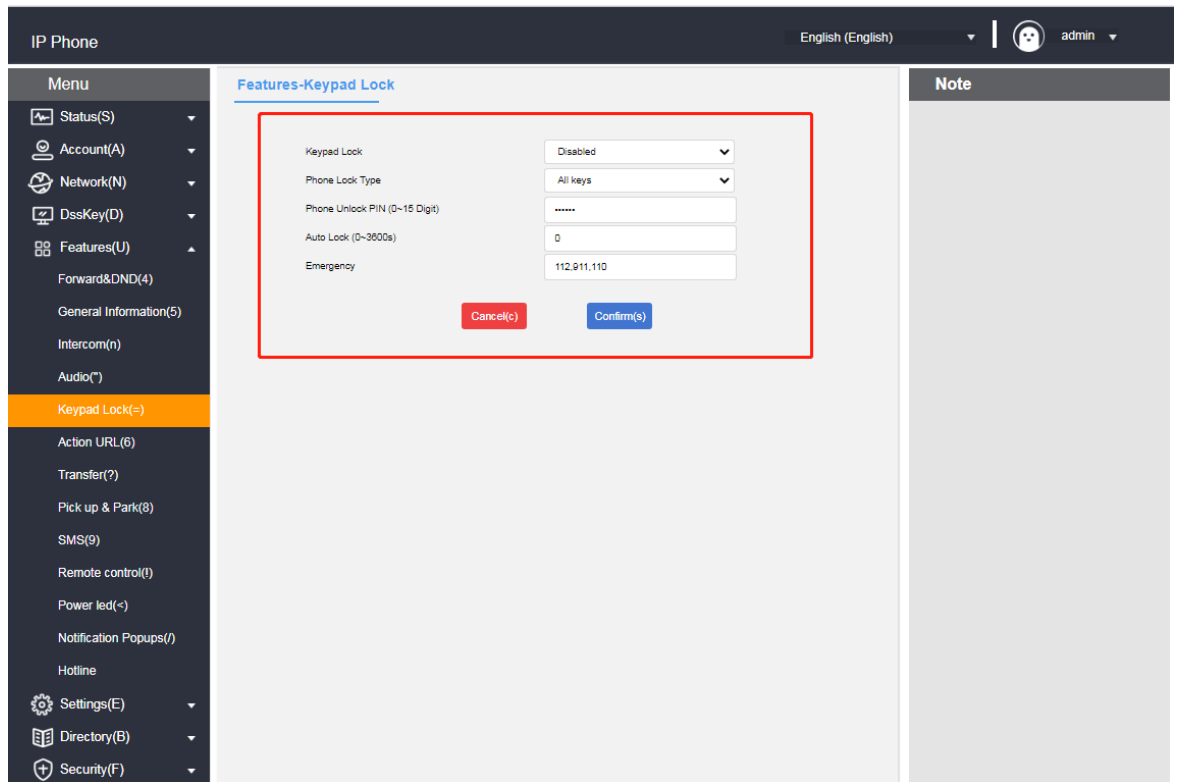

- Unlocking the keypad lock at the phone interface

1. Press the **Unlock** soft key or any locked key, Menu key, Function key, All key.
2. Enter the Unlock PIN at Unlock PIN (default PIN: admin).
3. Press the **OK** soft key.

Standby interface unlock soft key disappears, that is, successfully unlocked, long press  or wait for unlocking time will lock the key again.

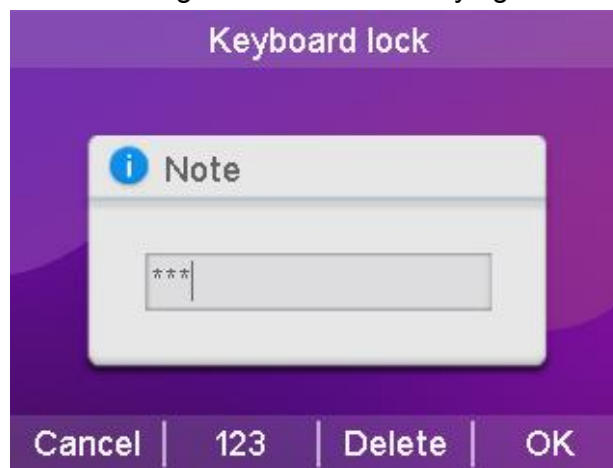

Instructions If you forget to unlock the PIN code, you can log in to the web interface to reset it.

Power lamp

The phone can set the power lamp status, when the phone is in a different state

the power lamp display is different, can also be set according to personal habits.

- Setting the power light on the web page

1. Log in to the phone page by IP address.
2. Click **Function (U) -> Power Lamp (<)**.
3. Set the power lamp status.
 - a. Default power indicator.
 - b. Power light flashes when ringing.
 - c. When there are voice and text messages the power lamp flashes.
 - d. Power indicator flashes when muted.
 - e. Power indicator flashes while holding a call.
 - f. Turn on the power light when talking or dialing.
 - g. The power indicator light flashes when an incoming call is not received.

Features-Power led

Common Power Light on	Disabled
Ringing Power Light Flash	Enabled
Voice/Text Mail Power Light Flash	Enabled
Mute Power Light Flash	Disabled
Hold/Held Power Light Flash	Disabled
Talk/Dial Power Light on	Disabled
MissCall Power Light Flash	Enabled

4. Submit for save operation.

Backlight

The IP Phone can set the backlight status. You can turn off the backlight when the phone is in a silent state for N seconds, or you can set it according to your personal habits.

- Setting the backlight on the web page

1. Log in to the phone page by IP address.

2. Click **Settings (E) -> Priority (i)**.

3. Set the backlight status.

a. Backlight time: Normal light / Normal dark / 10 seconds / 30 seconds / 1 minute / 2 minutes / 5 minutes / 10 minutes / 30 minutes.

Settings - Preference

Automatic breathe out	Disabled	▼
Automatic exhaling startup time (1~14 sec...)	4	
Backlight Time	30s	▼
Ring Type	Ring1.wav	▼
Upload Ringtone	Select the file	Browser Import
Upload BootUp	Select the file	Browser Import
ScreenSaver Time	Disabled	▼
ScreenSaver Mode	System	▼
Upload ScreenSaver	Select the file	Browser Import
watchdog	Enabled	▼

Cancel(c) Confirm(s)

4. Submit for save operation.

Pop-up notification window

The phone can be set up with a pop-up notification window to indicate whether or not to display a pop-up box alert when the phone has an unread call or message, or you can set it up according to your personal habits.

- *Setting up pop-up notification windows on web pages*

1. Log in to the phone page by IP address.

2. Click **Function (U) -> Popup Notification Window (/)**.

3. Set the popup notification window status.

- Display the voice message pop-up window.
- Show missed call pop-up window.
- Display the Transferred Incoming Calls pop-up window.
- Display a text message pop-up window.

Features-Notification Popups

Display Voice Mail Popup	Enabled
Display Missed Call Popup	Enabled
Display Forward Call Popup	Enabled
Display Text Message Popup	Enabled

Cancel(c)
Confirm(s)

4. Submit for save operation.

Boot Picture

The phone allows you to set the phone's power-up picture, which is displayed when the phone is powered up and started, to suit your personal habits.

- *Setting the boot image on the web page*

1. Log in to the phone page by IP address.
2. Click **Settings (E)** -> **Preference (i)**.
3. Import the boot image.
 - a. Requires a png image in 320*240 format.

Settings - Preference

Automatic breathe out	Disabled
Automatic exhaling startup time (1~14 sec...)	4
Backlight Time	30s
Ring Type	Ring1.wav
Upload Ringtone	Select the file Browser Import
Upload BootUp	Select the file Browser Import
ScreenSaver Time	Disabled
ScreenSaver Mode	System
Upload ScreenSaver	Select the file Browser Import
watchdog	Enabled

Cancel(c)
Confirm(s)

4. Submit for save operation.

Screensavers

The phone can be set up with a screen saver for the phone, which enters the screen saver mode when the phone has been inactive for a period of time, and can be set up according to your personal habits.

- *Setting a screensaver on a web page*

1. Log in to the phone page by IP address.
2. Click **Settings (E)** -> **Priority (i)**.
3. Set the screen saver status.
 - a. Screen saver on time: 10 seconds/30 seconds/1 minute/2 minutes/5 minutes/10 minutes/30 minutes.
 - b. Screensaver type: Custom/System.
 - c. Screensaver picture: 320*240 png format picture.

Settings - Preference

Automatic breathe out	Disabled	▼
Automatic exhaling startup time (1~14 sec...)	4	
Backlight Time	30s	▼
Ring Type	Ring1.wav	▼
Upload Ringtone	Select the file	Browser Import
Upload BootUp	Select the file	Browser Import
ScreenSaver Time	Disabled	▼
ScreenSaver Mode	System	▼
Upload ScreenSaver	Select the file	Browser Import
watchdog	Enabled	▼

Cancel(c) Confirm(s)

4. Submit for save operation.

Sound Settings

There are several sound settings inside the phone, including the following:

- [Volume settings](#)
- [Ringtone Setting](#)
- [keypad tone](#)
- [SMS alert tone](#)
- [signal tone](#)
- [Sound Gain](#)

Volume settings



The phone can set the ringing volume and the volume of the call process, the volume setting range is 1-15, the volume becomes bigger with the increase of the value.

- Setting the incoming call ringer volume in standby/ringing mode

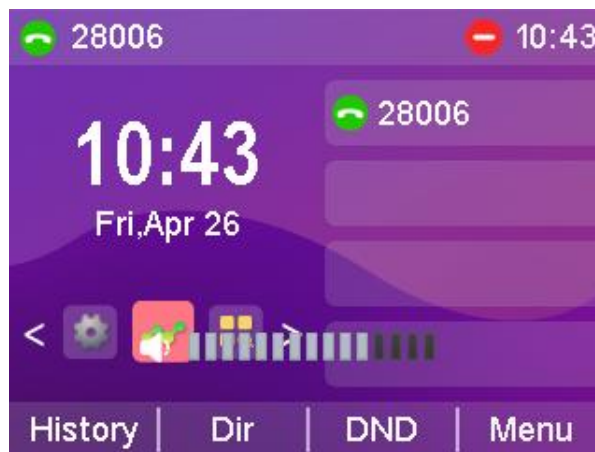
1. Press  or  to adjust the ringer volume, as follows.



- - Setting the volume of devices such as handset, speaker, headsets, etc. on incoming calls

1. Press  or  to adjust the call volume as shown.

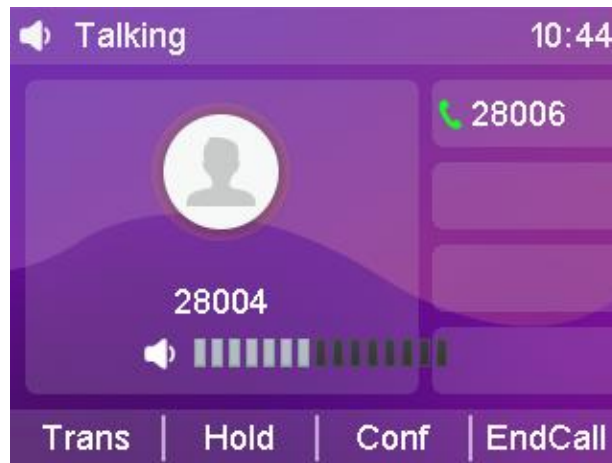

- Setting the ringing method

1. The ringing method can be configured in Web **Functions (U)** → **Sound**.

- a) Using Handsfree: Handsfree ringing;
- b) Using a headset: headset ringing;
- c) Using headset group and handsfree: headset & handsfree

synchronized ringing;



2. Click **Submit to** save the configuration.

Note: The headset ringing method only works when the phone is in headset mode:

Ringtone Setting

You can set different ringtones for your phone to distinguish incoming calls. In addition to unified ringtones, you can also set different ringtones for contacts to distinguish incoming calls from different contacts. There are 10 default ringtones to choose from.

- Setting the ringtone for incoming calls in the phone interface

1. Press **Menu->Settings->Basic Settings->Sounds->Ringtone**.
2. Press  or  for ringer selection.
3. Press the **Save** soft key to save the selected ringtone.



- Setting a contact's ringtone for incoming calls in a web browser

1. Log in to the phone page by IP address .
2. Press **Contacts (B)** -> **Local Contacts (x)**.
3. Add a contact or click a contact in the list to edit it.
4. Ringtone selection box for ringtone selection for this contact.
5. Click the **Add** button if you are adding a contact, or click the **Edit** button if you are modifying a contact.

are modifying a contact.

The screenshot shows the IP Phone web interface. The top bar includes 'IP Phone', 'English (English)', and a user profile 'admin'. The left sidebar has a 'Menu' with options like Status(S), Account(A), Network(N), DssKey(D), Features(U), Settings(E), and Directory(B). The main content area is titled 'Address book - local contacts' and contains a 'Local contact' form with fields for Name, Office Number, Mobile Number, and Other Number. A 'Ring' dropdown menu is open, showing options from Ring1.wav to Ring10.wav. The 'Add' button is highlighted with a red box. Below the form is a 'Group Setting' section and a 'Bulk Operation' section with buttons for 'Browser', 'Import CSV', and 'Export CSV'. At the bottom, there is a table of contacts with columns for Index, Name, Office Number, Mobile Number, Other Number, Ring, and a checkbox. The table has 8 rows. On the right side, there is a 'Note' section with information about the local directory and user group settings.

Keypad tone

The phone will emit a key tone when the keypad keys are pressed to indicate that the key has been triggered, and the key tone can be enabled and disabled through

the settings.

- Setting the phone key tones through the phone interface

1. Press **Menu->Settings->Basic Settings->Sound->Key Tone**.
2. Press the **Toggle** soft key to enable and disable the state of the key tone.
3. Press the **Save** soft key to save the operation.



SMS alert tone

Whether or not to play a "drop" tone when the phone receives a voice message or text message can be turned on or off from the web page.

- Setting SMS alert tones via web browser

1. Login to the phone page by IP address .
2. Press **Function (U) -> Basic Information (5)**.
3. Configure to turn on or off the voice message tone and SMS alert tone.
 - a) Enable/disable voice message tones;
 - b) Enable/disable SMS alert tone;
4. Press the **Submit** button to save.

Voice Mail Tone	Disabled
DHCP Hostname	
Reboot in Talking	Disabled
Hide Feature Access Codes	Disabled
Display Method on Dialing	User Name
RPort	Enabled
Channel Mode	Normal Mode
SMS Beep	Disabled

Signal tone

An audible signal sent by the switch to the user to indicate that the phone is in a certain state. The signal tone follows a uniform standard in each device, and you can customize the signal tone according to the national standard, or customize the signal tone; the lower the value, the more subdued the signal tone.

- Setting the signal tone through the web browser

1. Login to the phone page by IP address .
2. Press **Setup (E) -> Signal Tone (q)**.
3. According to the national standard please select the country, if you want to customize the signal tone, select custom in the country option.
4. Selecting Custom requires you to fill in your own values to change the signal tone.
5. Press the **Submit** button to save.

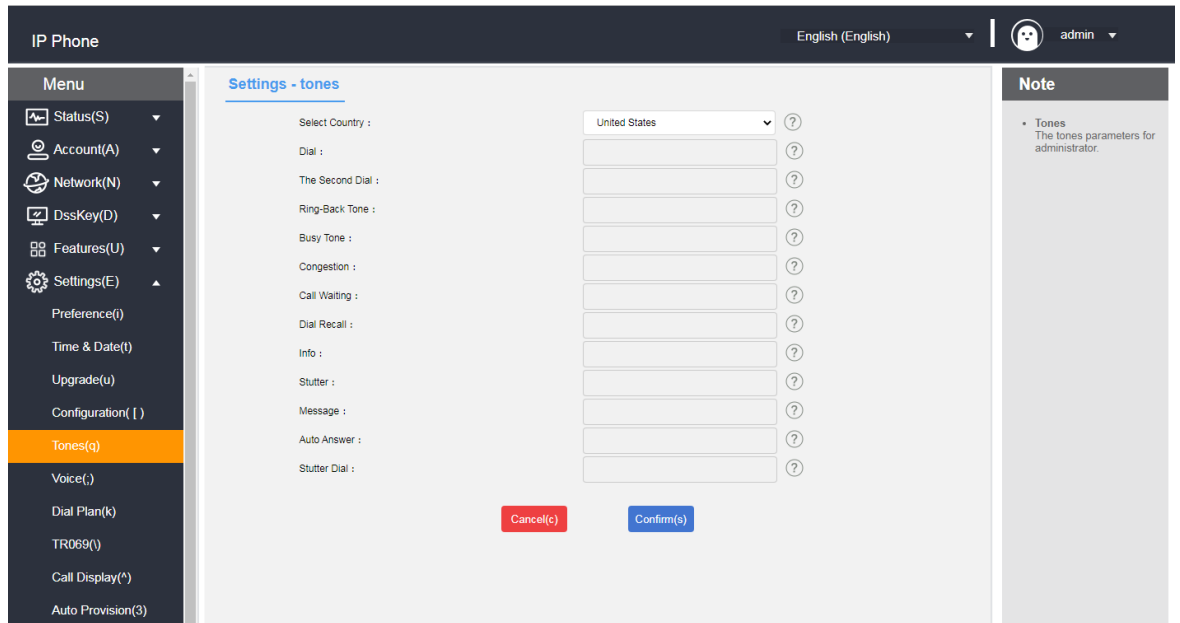

- Signal Tone Types Introduction and Standards

signal tone	frequency	Transmit frequency (dBm0)	clarification
dialer	450 ± 25	$-10 \pm 3\text{dBm0}$	Used to notify the calling subscriber that they are ready to dial
redial	450 ± 25	$-10 \pm 3\text{dBm0}$	Tone on second dialing
ring-back tone	450 ± 25	$-10 \pm 3\text{dBm0}$	Indicates that the called subscriber is in the ringing state
busy signal	450 ± 25	$-10 \pm 3\text{dBm0}$	Indicates that the line is busy or the called subscriber is busy for this connection.
network congestion tone	450 ± 25	$-10 \pm 3\text{dBm0}$	Indicates that this connection is experiencing line congestion
Call Waiting	450 ± 25	$-10 \pm 3\text{dBm0}$	Indicates that the phone is on call waiting
callback tone	450 ± 25	$-10 \pm 3\text{dBm0}$	Indicates that the phone is in the callback state
Special information	450 ± 25	$-10 \pm 3\text{dBm0}$	Beep when you receive a special message
Voice mail alert tone	450 ± 25	$-10 \pm 3\text{dBm0}$	Tone when you receive a voicemail message

message tone	450 ± 25	$-10 \pm 3\text{dBm0}$	Tone for incoming messages
auto-answer	450 ± 25	$-10 \pm 3\text{dBm0}$	In auto answer state beep
Voice Message Callback	450 ± 25	$-10 \pm 3\text{dBm0}$	Voice mail callback tone

Sound Gain

- Setting the sound gain through a web browser

1. Log in to the phone page by IP address .
2. Press **Setup (E)** -> **Voice (;)**.
3. Configure echo cancellation and RTP jitter buffers as required.
4. Press the **Submit** button to save.

Settings-voice

Echo Cancellation

ECHO Enabled

VAD Disabled

CNG Enabled

Jitter Buffer

Type Adaptive

Min Delay

Max Delay

Normal

- Setting the sound through the web browser

1. Log in to the phone page by IP address .
2. Press **Function (U)** -> **Sound (")**.

3. Configure the sound input/output values as required.

4. Press the **Submit** button to save.

The screenshot shows a configuration page titled "Features-Audio". It contains six dropdown menus for setting audio parameters:

Parameter	Value
Hands free volume input	34
Headphone volume input	26
Handle volume input	14
Headphone volume output	0
Handle volume output	0
Ringer Device for Headset	Use Speaker

At the bottom of the form are two buttons: a red "Cancel(c)" button and a blue "Confirm(s)" button.

Contact Management

Contact management for the IP Phones consists mainly of:

- [local contact](#)
- [blacklists](#)
- [LDAP settings](#)
- [Call History](#)
- [remote address book](#)
- [Update Address Book](#)
- [set up](#)

local contact

Local Contacts can save the contact's name, internal extension number, cell phone number, etc. It supports to save 1000 local contacts and 10 contact groups

(including default groups). It supports contact adding group, editing, setting ringtone, setting account number, editing contact and other operations.

Add Group

- Adding a group by phone

1. Press the soft key **Directory->Local Contacts->Create Group**.
2. Enter the group name in the Group Name input box.
3. Press the **Save** soft key to save the group.



- Adding Groups via Web Browser

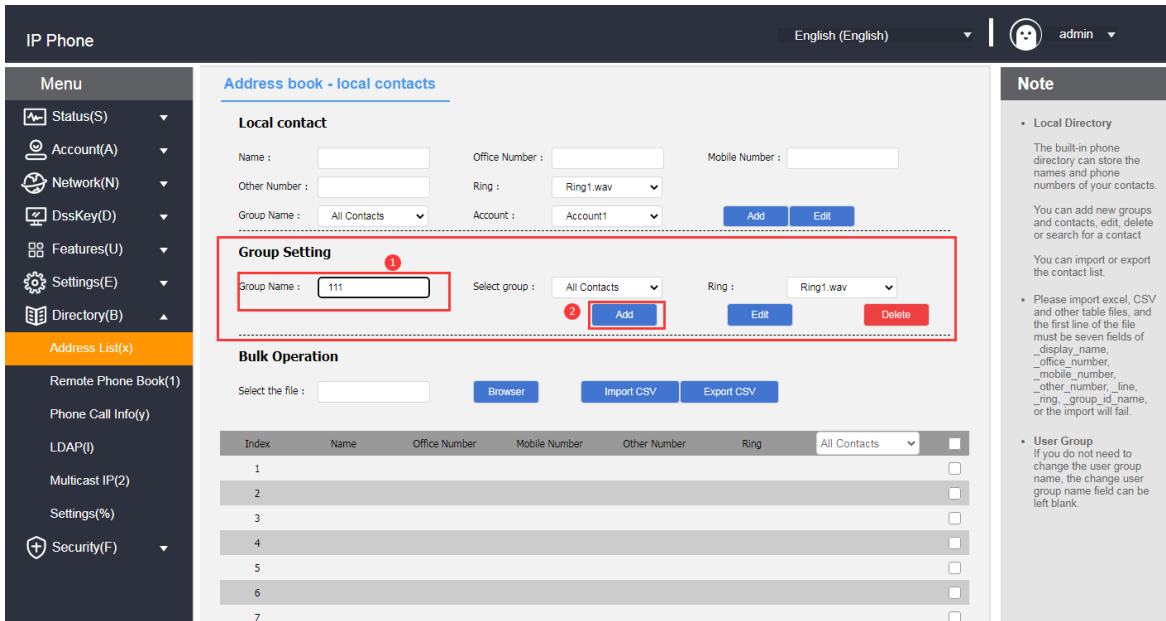

1. Log in to the phone page by IP address.
2. Click **Contacts (B) -> Local Contacts (x)**.
3. Enter the group name in Group Name.
4. Click the **Add** button to add a group.



Description of phone The phone can add up to 9 groups, and the default group All Contacts, a total of 10 groups, then add groups will prompt "group is full, can not add", if you need other groups, please edit the group or delete the original group and then add.

Edit Group

- Group editing via phone (default grouping cannot be edited)

1. Press the **Directory->Local Contacts** soft key.
2. Press  or  to select the group to be edited.
3. Press the softkey **Options->Detail** to enter the edit screen.
4. Enter a new group name in the Group Name edit box (only English can be entered in the phone interface).
5. Press the **Save** soft key to **save the group**.







- Editing of groups via web browser (default groupings cannot be edited)

1. Log in to the phone page by IP address.
2. Click **Contacts (B)** -> **Local Contacts (x)**.
3. Select the group.
4. After selecting, choose the group to become the input mode, and modify it to the name you want to change.
5. Click the **Edit** button to make changes.

Delete Groups

- Deletion of groups through the phone (default groups cannot be deleted)

1. Press the **Directory->Local Contacts** soft key.
2. Press  or  to select the group to be deleted.

3. Press the **Options** soft key.
4. Press  or  to select the delete option.
5. Press the **OK** soft key to delete.

To delete all contacts, press **Options -> Delete All**.

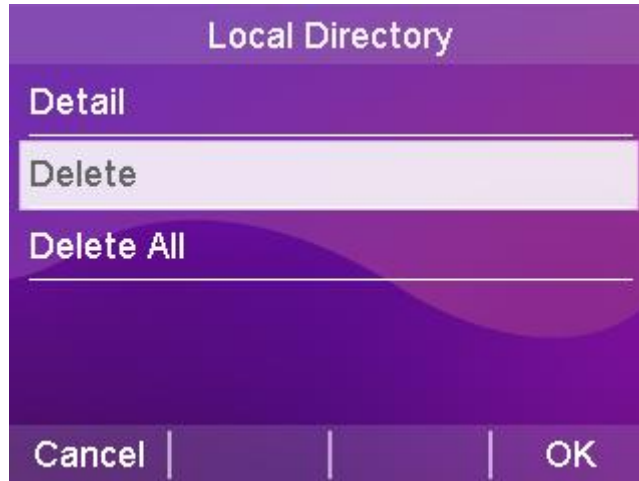

- Deletion of groups via web browser (default groups cannot be deleted)

1. Log in to the phone page by IP address.
2. Click **Contacts (B) -> Local Contacts (x)**.
3. Select the group in the Groups module.
4. Click the **Delete** button in the Group Settings module to delete it.

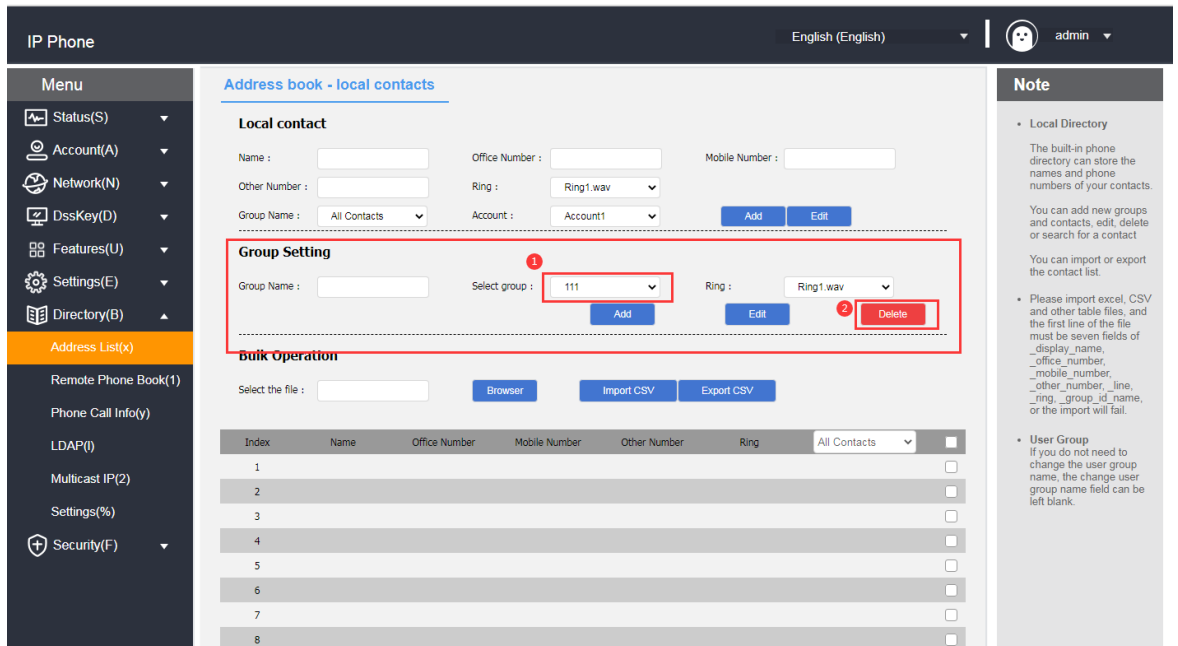





Add Contact

Contacts can be used in the following three ways:



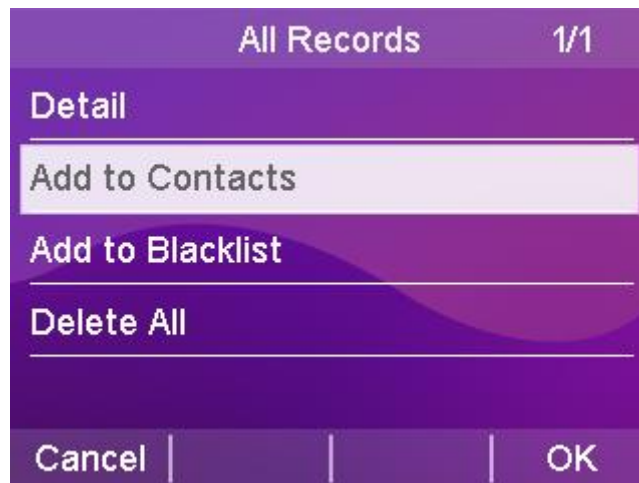

- Add manually
- batch import
- Add from call log

- Adding a contact via call history through a phone interface

1. Press the **History** soft key in standby.
2. Press  or  to select the number to add as a contact.
3. Press the softkey **Options -> Add to Contacts**.
4. Press  or  to complete the contact information (name, group).
5. Press **OK** to save the contact.



- Adding contacts via local contacts in the phone interface

1. Press the **Directory->Local Contacts** softkey in the standby screen (or press **Menu->Directory->Local Contacts**).
2. Press  or  to select the group to which you want to add contacts.
3. Once in the group, press the **Add** soft key to enter the Add screen.
4. Press  or  to fill in the contact information (name, phone number, you can switch to another group).
5. Press the **Save** soft key to save the contact.



- Adding contacts via web browser

1. Log in to the phone page by IP address.
2. Click **Contacts (B)** -> **Local Contacts (x)**.
3. Local Contacts module fills in the contact information.
4. Click the **Add** button in the Local Contacts module to add it.

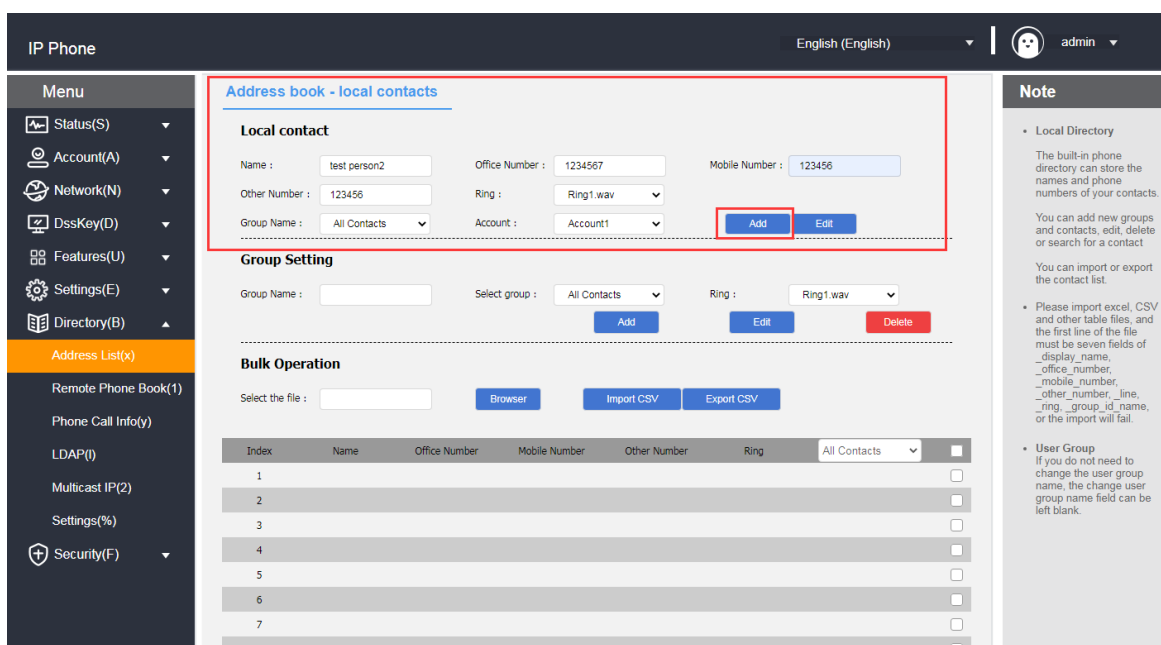

- Bulk import of contacts via web browser

1. Log in to the phone page by IP address.
2. Click **Contacts (B)** -> **Local Contacts (x)**.
3. Batch operation module click CSV format export contact template.
4. Add/edit contact information in the form.
5. Batch operation module click Browse to find the CSV file to be imported, click **CSV format to import** to add contacts.
(Currently only supports importing xls, csv, xlsx file types) .

	A	B	C	D	E	F	G	H	I	J	K	L	M	N
1	_display_	_office_r	_mobile_r	_other_nu	_line	_ring	_group_id	_name						
2	Tony	1234				1	Ring1.wav	All Contacts						
3	Dave	1235				1	Ring1.wav	All Contacts						
4														
5														
6														
7														
8														
9														
10														
11														
12														
13														
14														
15														
16														
17														
18														
19														

The following prompt appears after you click Import:

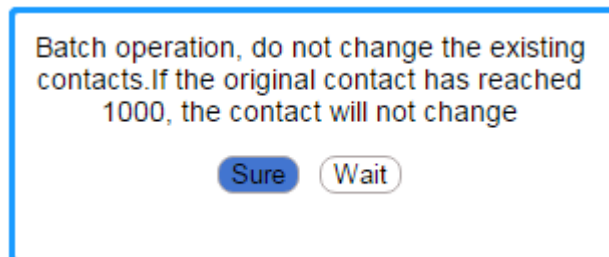

Edit Contact



- Editing contacts through the phone interface

1. In standby mode, press Directory->**Local Directory** softkey (or

Menu->Directory>Local Directory)->All Contacts.

2. Press  or  to select the contact name to edit.

3. Press the softkey **Options->Details** to enter the contact editing page.

4. Press  or  to select the contact information to edit.

5. Press **OK** to save the editing operation.



- Editing contacts via web browser

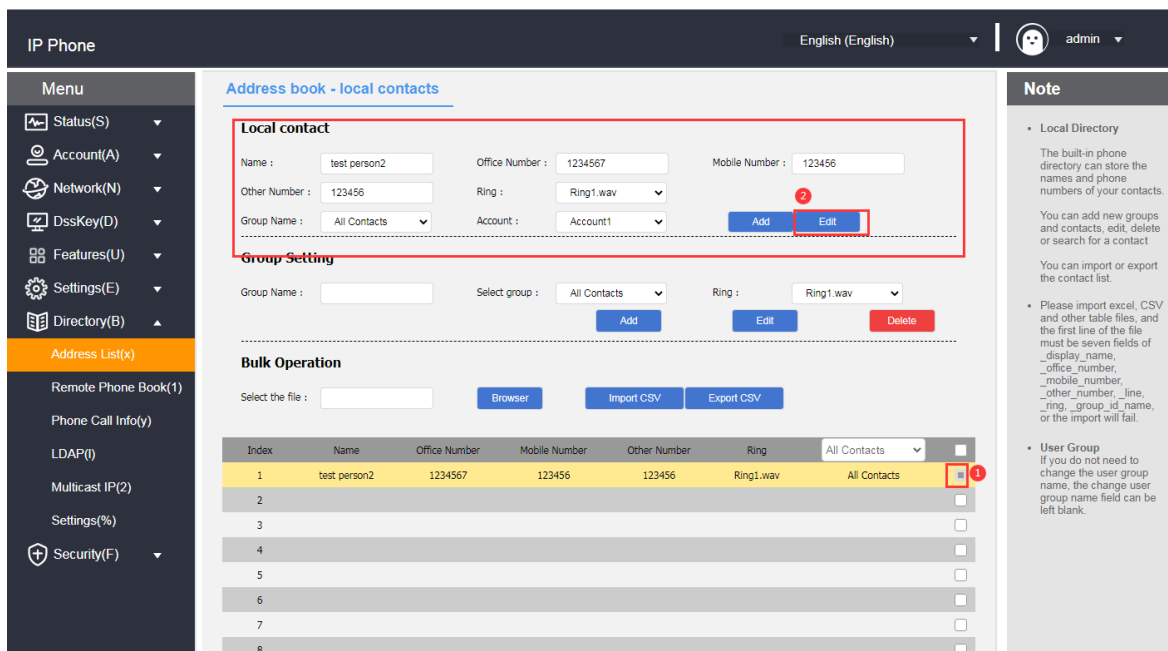

1. Log in to the phone page by IP address.
2. Click **Contacts (B) -> Local Contacts (x)**.
3. Tap the contact you want to edit in the contact list below, and the information will be filled into the local contact module.
4. Modify the contact's information in the Local Contacts module.
5. Click the **Edit** button to save the editing operation.



Delete Contacts

- Deleting contacts through the phone interface

1. In standby mode, press **Directory->Local Contacts** softkey (or **Menu->Directory->Local Contacts)->All Contacts**.

2. Press  or  to select the contact name to delete.
3. Press **Options->Delete/Delete All**.
4. Press the **OK** soft key to delete.

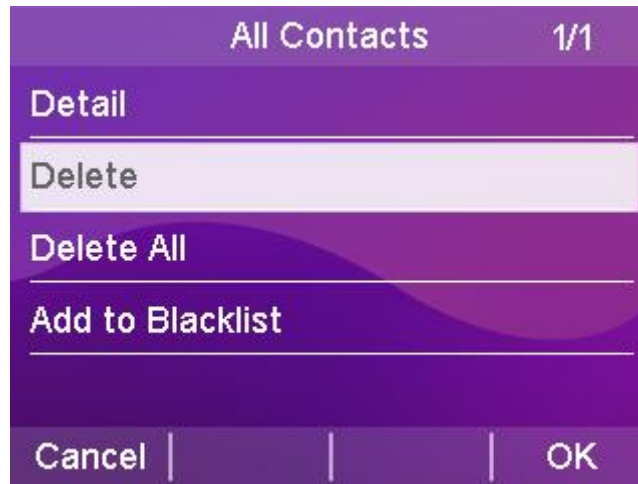

- Deleting contacts via web browser

1. Log in to the phone page by IP address.
2. Click **Contacts (B) -> Local Contacts (x)**.
3. Tap the contact you want to delete in the contact list below.
4. Click the **Delete/Delete All** button under the list to delete the contact.



The screenshot shows a web interface for managing contacts. On the left is a sidebar menu with options like Network(N), DssKey(D), Features(U), Settings(E), Directory(B), Address List(x), Remote Phone Book(1), Phone Call Info(y), LDAP(I), Multicast IP(2), Settings(%), and Security(F). The main area has a top bar with fields for 'Other Number' (123456), 'Ring' (Ring1.wav), 'Group Name' (All Contacts), and 'Account' (Account1). Below this are sections for 'Group Setting' and 'Bulk Operation'. The 'Bulk Operation' section contains a table of contacts with columns for Index, Name, Office Number, Mobile Number, Other Number, Ring, and a dropdown menu. The table has 10 rows, with the first two rows containing data. A red box highlights the 'Delete' button in the footer of the table, which also includes 'Delete All', 'Move To', and 'All Contacts' options.

Description Deleted contacts are not recoverable, confirm that you want to delete them before deleting them.



call a contact person

- Calling local contacts through the phone interface

1. In standby mode, press the softkey **Directory->Local Contacts (or Menu->Directory->Local Contacts)->All Contacts**.

2. Press  or  to select the name of the contact to call.

3. Press the **Send** soft key to enter the contact number list.

4. Press  or  to select the number you want to call to make the call.

5. Press the **Send** soft key to make a call.

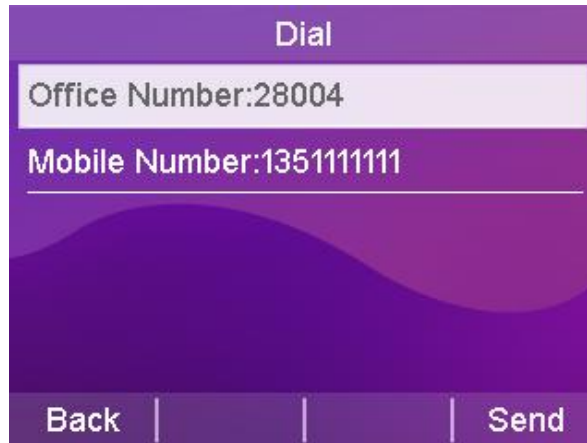

Blacklists

The phone can save up to 30 blacklisted contacts, and phone numbers with blacklists set will be automatically rejected by the phone.

Add Blacklist



- Adding a blacklist through the phone interface

1. In standby mode, press the softkey **Menu->Directory->Blacklist->Add**.

2. Press  or  to select Edit Blacklist Information (Name, Number).

3. Press the **Save** soft key to save the changed blacklist members.

- Adding blacklists from call history through the phone interface

1. Press the **History** soft key in standby.
2. Press  or  to select a number to add to the blacklist.
3. Press the soft key **Options** -> **Add to Blacklist**.
4. Completion of information on blacklisted members.
5. Press **OK** to save the blacklist.

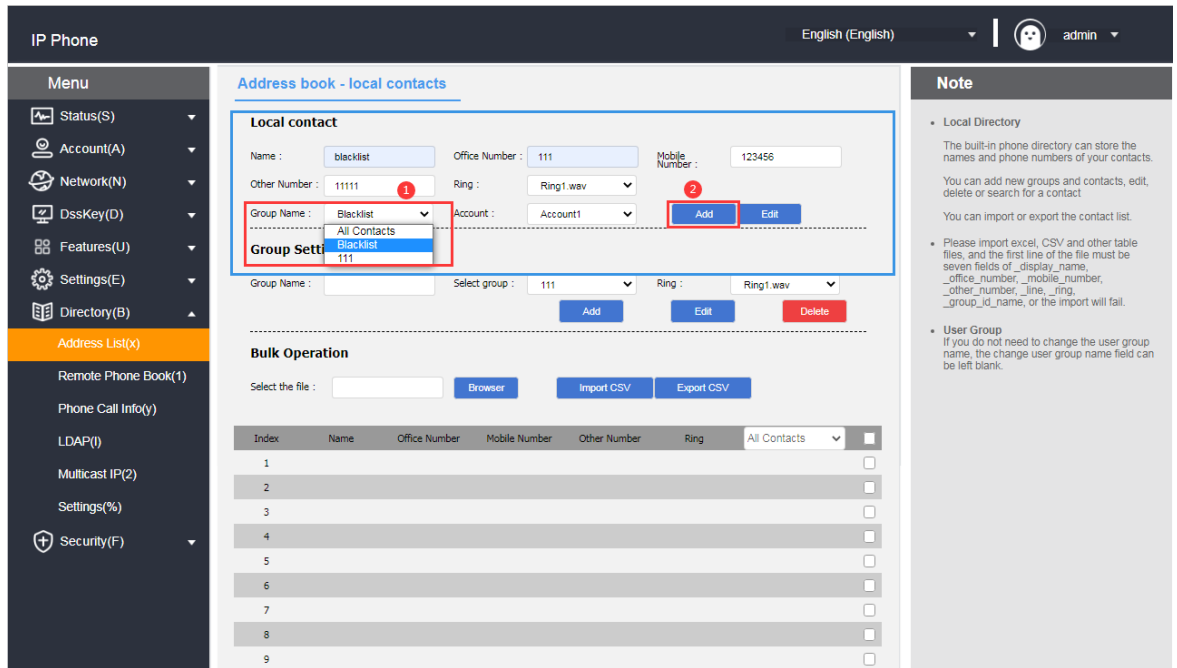

- Blacklisting via web browser

1. Log in to the phone page by IP address.
2. Click **Contacts (B)** -> **Local Contacts (x)**.
3. Fill in the name and phone number to be added to the blacklist in the Local Contacts module, and select the grouping as BlackList (BlackList).
4. Click the **Add** button to save the blacklisted contacts.



Delete Blacklist

- Blacklist removal through the phone interface

1. In standby mode, press the soft key **Menu->Directory->Blacklist**.
2. Press  or  to select the blacklist member to be deleted.
3. Press **Options->Delete/Delete All**.
4. Press the **OK** soft key to delete.

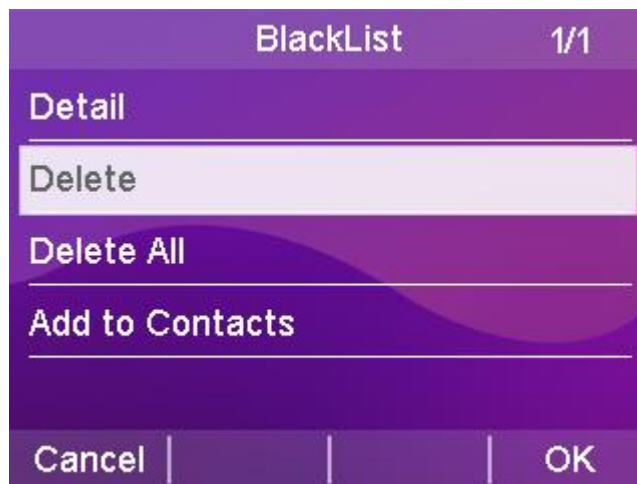

- Blacklist removal via web browser

1. Log in to the phone page by IP address.
2. Click **Contacts (B) -> Local Contacts (x)**.
3. Select BlackList from the Contacts list drop-down box below.
4. Check the blacklists to be deleted.

5. Click the Delete/Remove All button under the list to remove the blacklist.

The screenshot shows the 'Bulk Operation' section of the IP Phone user interface. A table lists contacts with columns for Index, Name, Office Number, Mobile Number, Other Number, and Ring. A dropdown menu is open over the 'All Contacts' column, showing options: 'All Contacts', 'Blacklist', and 'R&D'. A red box highlights the 'Blacklist' option. Below the table, a red box highlights the 'Delete All' button. A sidebar on the left contains navigation options like 'Network(N)', 'DssKey(D)', 'Features(U)', 'Settings(E)', 'Directory(B)', 'Address List(x)', 'Remote Phone Book(1)', 'Phone Call Info(y)', 'LDAP(i)', 'Multicast IP(2)', and 'Security(F)'. A sidebar on the right contains instructions for adding groups and contacts, and a note about user groups.

Index	Name	Office Number	Mobile Number	Other Number	Ring	
1	Ai1	1234			Ring1.wav	All Contacts
2	Ai2	1235			Ring1.wav	All Contacts
3	Ai3	1236			Ring1.wav	All Contacts
4	Ai4	1237			Ring1.wav	All Contacts
5	Ai5	1238			Ring1.wav	All Contacts
6	Ai6	1239			Ring1.wav	All Contacts
7	Ai7	1240			Ring1.wav	All Contacts
8	Ai8	1241			Ring1.wav	All Contacts
9	Ai9	1242			Ring1.wav	All Contacts
10	Ai10	1243			Ring1.wav	All Contacts

999/1000 Skip to 1 < > Delete All Delete Move To All Contacts

Copyright ©2021 *Inc. All Rights Reserved

LDAP Configuration

Functional Description

LDAP (Light Directory Access Protocol) is an application layer protocol that runs on IP networks and provides a range of functions for accessing and maintaining distributed directory information services. Simply put, LDAP is a fast way to get centralized static data about people or resources, and is most useful for storing information that needs to be read from different locations, but doesn't need to be updated often. LDAP is very effective at storing a company's employee phone book and organization chart, and is especially handy for querying information. For example: in accordance with the tree structure, the root of the tree is the name of the company, the next logical branch out of the various departments, departments can be branched out of the next various employees can be in a certain range in accordance with specific rules to retrieve contacts, such as retrieval of a company's hardware department name contains "J" of the employees.

You can configure the phone to connect to an LDAP server that supports LDAPv2 or LDAPv3. The phone supports the following LDAP servers:

- Microsoft Active Directory
- Sun ONE Directory Server
- Open LDAP Directory Server
- Microsoft Active Directory Application Mode (ADAM)

The biggest advantage of LDAP is that users can quickly look up contacts from LDAP server without the need to maintain a local phonebook. The contact information returned by the LDAP server is read-only. Users can call LDAP contacts but cannot add, edit or delete LDAP contacts. Administrators can configure the filter conditions of LDAP query on the phone, such as displaying the contact information and how to sort the contacts. IP phones perform LDAP query on the phone. The administrator can configure the filters for LDAP query on the phone, such as the number of contacts to be displayed, the information to be returned, and how to sort the contacts, etc. IP phones perform LDAP search on the phone:

Enter the search directly into the pre-dial/dialing screen (make sure LDAP is enabled on the caller's contact match list) and the phone will perform a query from an LDAP server. If results are available, they are displayed on the LCD screen and the user can select a contact and initiate a call.

Press LDAP programmable button or press Menu->Contacts->LDAP, enter the content to be searched in the LDAP search interface, the phone will query the related contacts from the LDAP server and display them on the LCD interface, the user can select a certain contact and initiate a call, or add the contact to the local address book or black list.

The phone sends a search request to the LDAP server, which searches all contacts based on the search input and configured filters, and then returns the matching results to the phone.

Configuring the LDAP Server

The following examples are for reference only. You can modify the LDAP attribute values according to your specific needs.

1. Open the Web interface of the phone and log in.
2. Click **Contacts -> LDAP**.
3. Configure the LDAP service as shown in the following example:

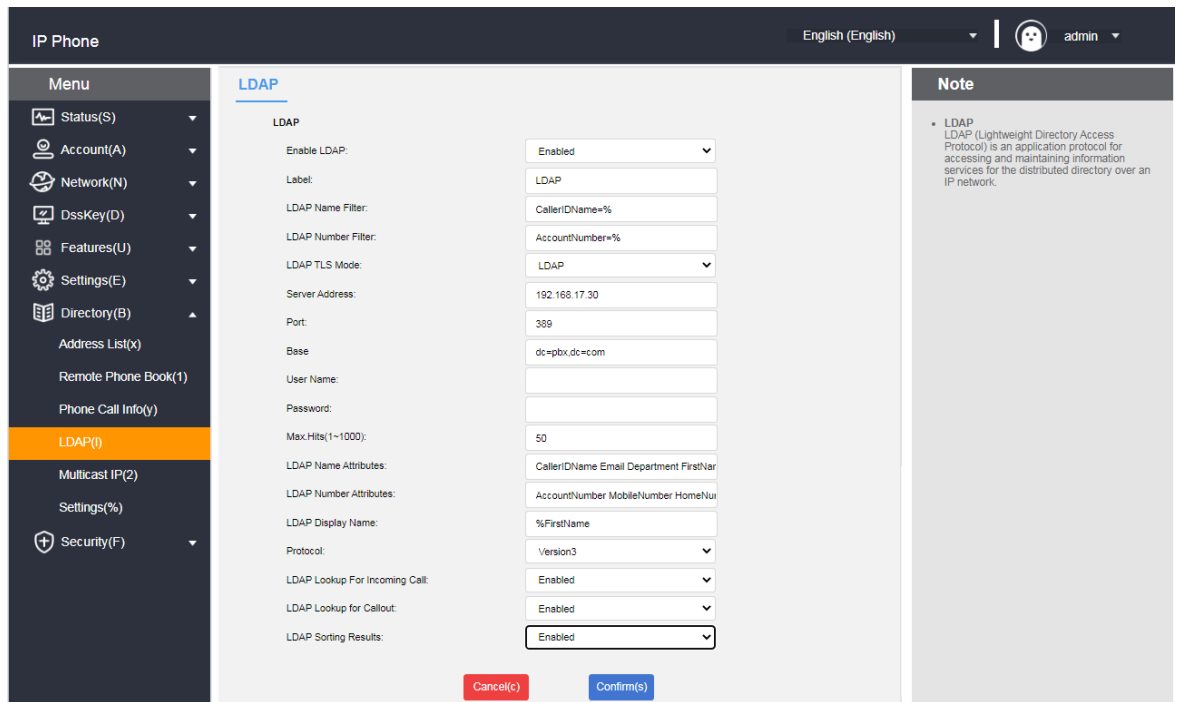

LDAP Setup Instructions

LDAP settings	clarification	typical example
Start LDAP	Enables or disables LDAP function.	Enable
LDAP Tags	Fill in the name of the phone book.	Telephone Directory
LDAP Name Filtering	Sets whether or not the phone can search for contact information by "Nickname" or "Last name". * stands for the arbitrary letter. The % represents the string entered and is used to filter the prefix criteria.	(CallerIDName=%)
LDAP Number Filtering	Set whether the phone can search for contact information by "Cell phone number, office number, or home number". * stands for the arbitrary letter. The % represents the string entered and is used to filter the prefix criteria.	(AccountNumber=%)
LDAP encrypted transfer mode	Set how the LDAP server connects to the IP phone :	LDAP

	<p>①LDAP ②LDAP TLS Start ③LDAPS</p> <p>Note: The S-Series small and medium IPPBX supports LDAP protocol.</p>	
LDAP server address	Fill in the IP address of the PBX.	192.168.17.30
Ports	Fill in the LDAP server address port.	389
Base	<p>Fill in the root node of the LDAP server or one of the phonebook nodes from which the LDAP server will start searching for contacts.</p> <p>① Fill in the directory node of the LDAP server, and the LDAP server will search for contacts from all phone books.</p> <p>② Fill in a certain phonebook node, and the LDAP server will search for contacts from this phonebook.</p>	dc=pbx,dc=com
User Name	Fill in the user name of the LDAP server.	Username provided by the LDAP server
Password	Fill in the password for the LDAP server.	Password provided by the LDAP server
Maximum number of hits (1~1000)	Set the maximum number of entries in the LDAP server search results.	50
LDAP Name Attributes	Set the name attribute to be acquired. Multiple name attributes can be set, separated by spaces.	CallerIDName Email Department FirstName LastName
LDAP Number Properties	Set the number attributes to be acquired. Multiple number attributes can be set, each separated by a space.	AccountNumber MobileNumber HomeNumber Fax
LDAP Display Name	Set the name to be displayed for LDAP server search results. The display name format must begin with %.	%FirstName
protocol version	<p>The version of the LDAP server protocol.</p> <p>Note: The S-Series small and medium IPPBX supports version 3.</p>	3
LDAP Matching Calls	Sets whether or not LDAP searches are performed on incoming calls.	Enable



LDAP Outbound Queries	Set whether to search for numbers in the LDAP phonebook when making a call.	Enable
LDAP Search Sorting	Sets whether or not the search results are sorted in numeric or alphanumeric order.	Enable

Search for LDAP contacts via Address Book

- Enabling LDAP Phonebook

1. Log in to the phone web interface and click **Contacts -> LDAP**.
2. Enable LDAP phonebook.
3. Click **Submit**.

- Search LDAP Contacts

1. Log in to the phone's web interface and click **Menu -> Contacts -> LDAP**.
2. Enter the number or name of the contact, and the contact information that matches the search criteria is displayed on the screen.
3. Use  or  to select a contact.
4. Press the **Send** soft key to initiate the call.

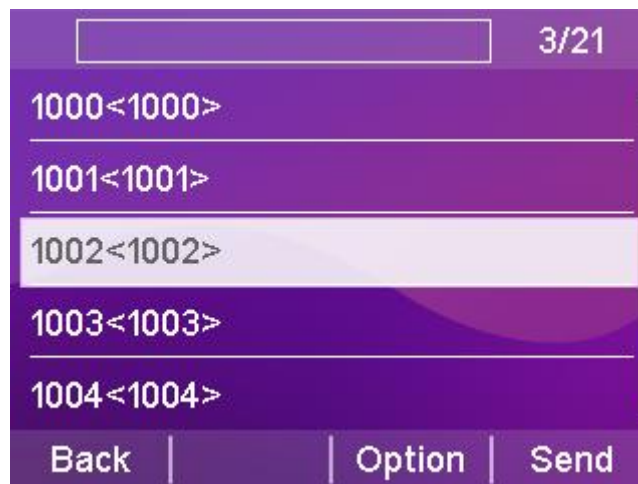

Call Record Management

Call records contain dialed numbers, missed calls, received calls, and transferred calls. Each record supports up to 300 records.

You can view, delete, add contacts, add blacklists, and so on. For more information about the operation of contacts, please see [Contacts Management](#) section.

- Viewing the call record through the handset interface

1. Press the **History** soft key, the LCD display shows a list of numbers for the recent call records.

2. Press  or  to select the record you want to view.

3 Press the softkey **Options->Details**. Details of the record can be viewed.

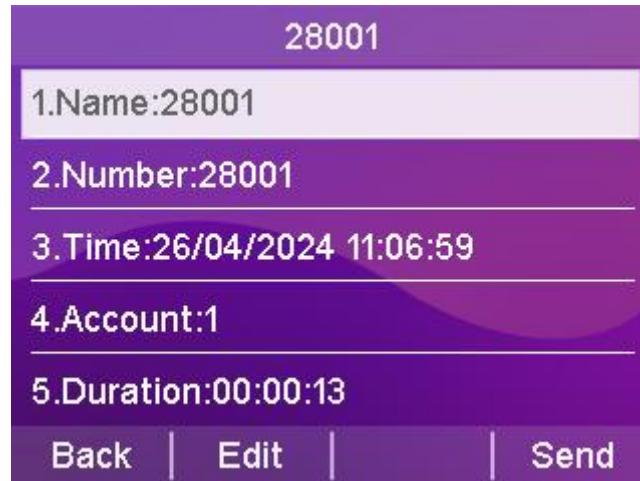



- Viewing of call history through a web browser

1. Log in to the phone page by IP address.

2. Click **Contacts (B) -> Call History (y)**.

The screenshot shows the 'Phone Call Info' page in the IP Phone web interface. The left sidebar contains a 'Menu' with options like Status(S), Account(A), Network(N), DssKey(D), Features(U), Settings(E), Directory(B), Address List(x), Remote Phone Book(1), Phone Call Info(y), LDAP(l), Multicast IP(2), Settings(%), and Security(F). The main content area is titled 'Phone Call Info' and includes a 'Call Panel' with a 'Dial Number' input field and 'Dial' and 'Hang Up' buttons. Below the 'Call Panel' is a 'Call Log' section with three tables: 'Dialed List', 'Missed List', and 'Received List'. The 'Dialed List' table has two entries, the 'Received List' has one entry, and the 'Missed List' is currently empty. A 'Note' section is visible on the right side of the interface.

- Calls made through phone record

1. Press the **History** soft key while the phone is in standby.
2. Press  or  to select the number to dial.
3. Press the **Send** soft key to dial.



- Calls made through the web page

1. Log in to the phone page by IP address.
2. Click **Contacts (B) -> Call History (y)**.
3. Enter the call number and press Dial to send the call.

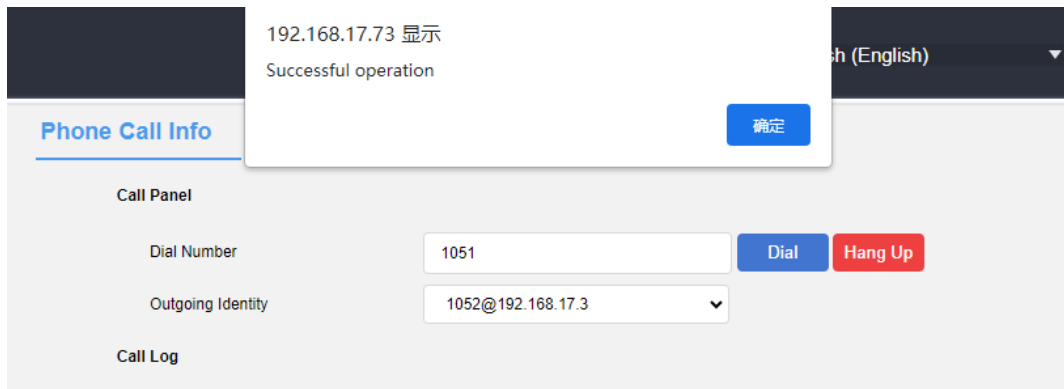

- Hang up through the web page

1. Log in to the phone page using the IP address.
2. Tap Contacts (B) -> Call History (y).
3. When the phone is in the talking, incoming, or dialing state, tap Hang up.

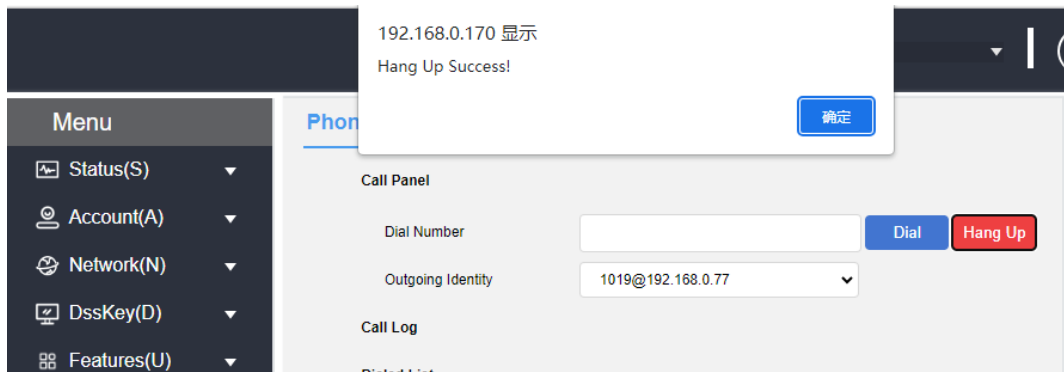

Remote address book

Functional Description

Remote Phone Book (Remote Phone Book) from the name can be visualized as a remote access address book. Administrators need to add the established format of XML to the remote server, the phone by accessing the remote address book to achieve the purpose of expanding the scope of the address book. It is mainly used in the enterprise to facilitate the update of the enterprise address book, maintenance at the same time can save the phone's memory to do a double whammy.

The phone supports accessing the XML file on the HTTP/HTTPS/FTP/TFPT server, reading the contact information in the XML file and displaying it on the screen of the phone to realize the remote address thin function.

XML format

```
<?xml version="1.0" encoding="UTF-8"? >
<SLIPPhoneMenu>
```

```

<T>Company I</T>
<M N="group">
  <U N="Zhang San" P1="6131" P2="4566" P3="6788" d_p="Resource:"/>
  <U N="Li Si" P1="6136" P2="4567" P3="6789" d_p="Resource:"/>
</M>
<M N="Group II">
  <U N="Wang Wu" P1="1234" P2="4566" P3="6788" d_p="Resource:"/>
  <U N="Bull I" P1="1235" P2="4567" P3="6789" d_p="Resource:"/>
  <U N="Zhang San" P1="1006" P2="4566" P3="6131" d_p="Resource:"/>
</M>
</SLIPPhoneMenu>

```

Phone Configuration Remote Address Book

1. Put the XML complying with rules to the remote server that can be accessed.
(About server building there is a detailed description in the automatic update chapter, do not repeat here).

2. Web page click **Address Book -> Remote Address Book**.

3. Configure the remote address book service. An example is shown below:

Directory-Remote Phone Book

Index	Remote URL	Display Name
1	<input type="text" value="http://192.168.17.68:8099/lvswitche.xml"/>	<input type="text" value="远程地址簿"/>
2	<input type="text" value="http://192.168.17.68:8099/lvswitches.xml"/>	<input type="text" value="Remote Book"/>
3	<input type="text"/>	<input type="text"/>
4	<input type="text"/>	<input type="text"/>
5	<input type="text"/>	<input type="text"/>



Incoming/Outgoing Call Lookup

Search Flash Time(Seconds)

Cancel(c)
Confirm(s)



Using the Remote Address Book

- View Remote Address Book

1. Press Phone **Menu** -> **Contacts** -> **Remote Address Book**.
2. Use  or  to select the list.
3. Press the **Enter** soft key to view the corresponding remote address book.



- Search Remote Address Book

1. Press Phone **Menu** -> **Contacts** -> **Remote Address Book** -> **Search**.
2. Enter the number or name of the contact, and the information of the contact that matches the search criteria is displayed on the screen.
3. Use  or  to select a contact.
4. Press the **Call** soft key to initiate a call.
5. Press the **Options** soft key to view the contact information or add to Contacts/Blacklist.

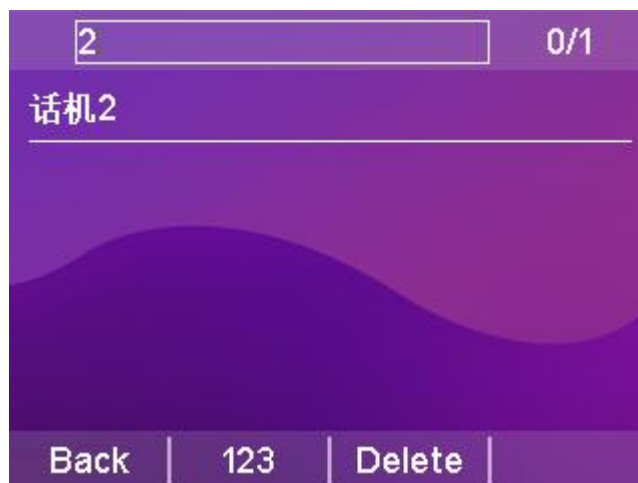

Update Address Book

- Remote updating of address book via web page

The Remote Update Contacts feature makes it easy to update local contacts without having to maintain a separate address book for each person. Files with the same MobileNum contacts in front will be overwritten by the later contacts.

1. Log in to the phone page by IP address.
2. Click **Address Book (B) -> Remote Update Address Book**.
3. Configure updated address book information.
 - a) Server URL: support http/https/ftp/tftp path;
 - b) Automatic update: enable/disable;
 - c) Time: Fixed time of the day;
 - d) Update Now: Click the button to update automatically;

Update Directory

Update Directory

Server URL	<input type="text" value="tftp://192.168.17.70/Phonebook.xml"/>
Auto Provision	<input type="text" value="Disabled"/>
Time	<input type="text" value="0"/> : <input type="text" value="0"/> : <input type="text" value="0"/>
Update now	<input type="button" value="Update now"/>

4. Click Submit to save the configuration;

The file format is as follows, just upload it to the server after configuration.

```
<?xml version="1.0" encoding="utf-8"? >
<all>
  <PhoneBooks>
    <book  FirstName="adm"  LastName="gj"  MobileNum="456"  OfficeNum="123"
    OtherNum="789" />
  </PhoneBooks>
</all>
```

Address Book Settings

The phone supports Address Book Enable/Disable and Caller Contact Match List Enable/Disable.

- Enable/Disable Address Book via Web

1. Log in to the phone page by IP address.
2. Click **Contacts (B) -> Settings (%)**.
3. Select the address book you want to enable, you can set local contacts, call log, remote address book, blacklist, LDAP.
4. Adjust the sorting by ↑ ↓ key and then submit;

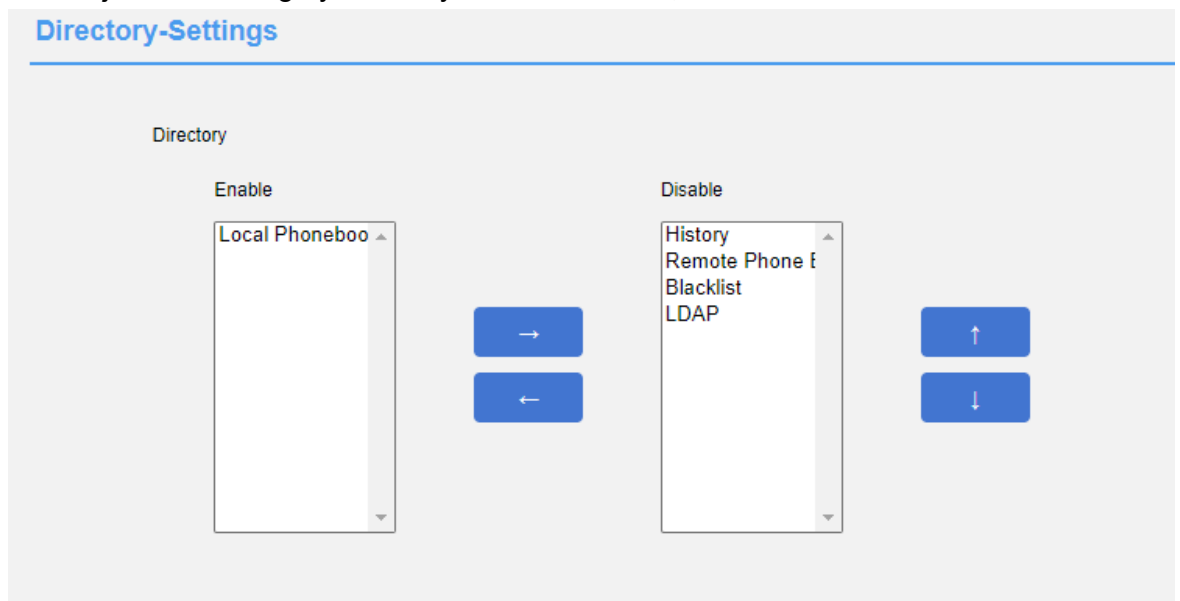

- Enable/disable caller contact matching via web page

1. Log in to the phone page by IP address.
2. Click **Contacts (B) -> Settings (%)**.
3. Select the matching list of caller contacts to be enabled, you can set local contacts, call logs, remote address book, LDAP.
4. Adjust the sorting by ↑ ↓ key and then submit;

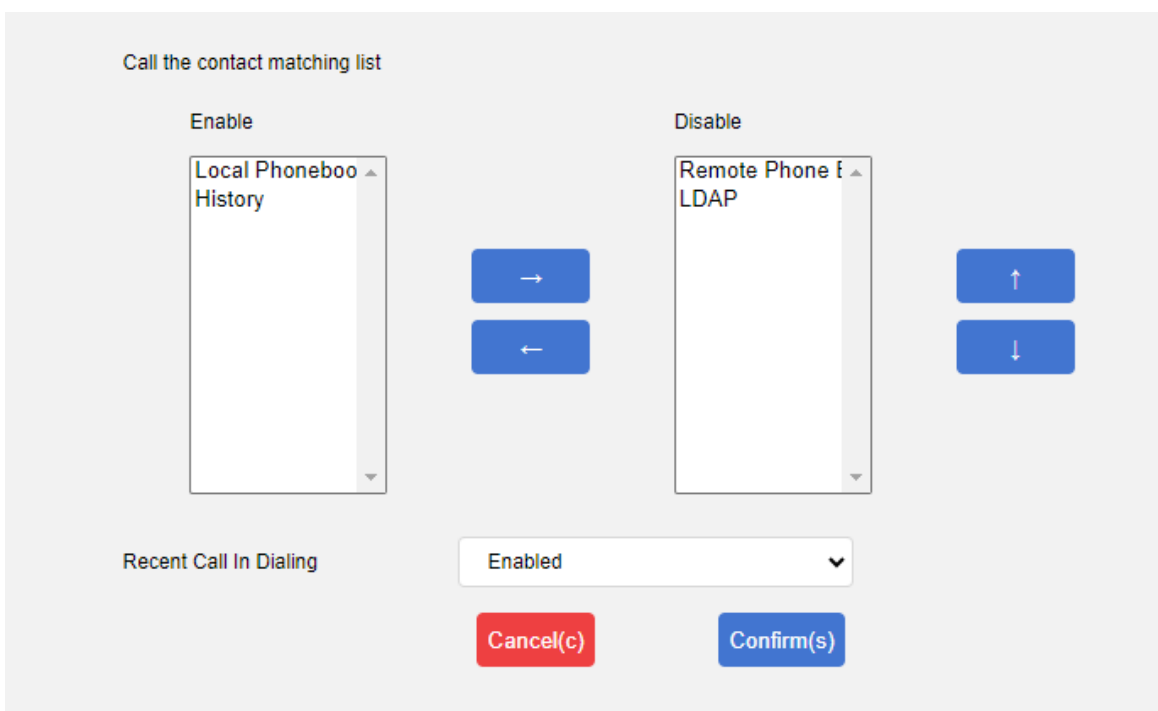

Accessory Customization

The phone can be used with a variety of accessories, the main ones are listed below:

- [headset](#)
- [extension desk](#)

Headset use

The phone can be used with a headset. Before using the phone, you need to connect the headset and activate the headset mode by using the function button  (Headset) on the panel of the phone, for the installation of the headset, please see [Headset Installation](#) chapter.

- Activate headset mode

1. Press the key  (Headset) on the phone panel.

The icon in the upper left corner on the LCD screen changes to the headset icon  .

When the handset receives an incoming call, press the Answer soft key to answer the call and the handset automatically enters headset talk mode.

Dial a number and press the Send key, the phone will automatically make a call using the headset mode.

- Exit headset mode:

1. Press the key  (Headset) on the phone panel.

The LCD screen shows that the icon in the upper left corner changes to .

- Dual headset mode:

To use the dual-headset mode you must access the headset and handle, after successful configuration one can hear and speak over the headset, but one can only listen to via handle.

1. Log in to the phone page by IP address.
2. Click on **Functions (U)** -> **Basic Information (5)**.
3. Configure to enable/disable the dual headset feature.
4. Click Submit to save the configuration.

Allow Mute	Enabled	▼
Dual Headset	Disabled	▼
Auto Answer Delay	1	
Headset Prior	Disabled	▼
Fwd International	Enabled	▼

Description The Dual Headset feature can only be configured via the web and must be accessed with both the handle and the headset.

The headset mode needs to be activated when the phone needs to be used after the configuration is successful.

No response from picking up and putting down the handle after turning on the dual headset mode.

- Headphones are preferred:

The Headset Priority feature is for those who use headphones frequently or full-

time.

1. Log in to the phone page by IP address.
2. Click on **Functions (U) -> Basic Information (5)**.
3. Configure to enable/disable the headset priority feature.
4. Click Submit to save the configuration.

Auto Answer Delay	1
Headset Prior	Disabled ▼
Fwd International	Enabled ▼
Diversion/History-Info	Enabled ▼

Description The Headset Priority feature can only be configured via the web and the headset must be accessed.

The headset mode needs to be activated when the phone needs to be used after successful configuration.

Pressing the handsfree button after activating headset mode in headset priority mode will not exit headset mode.

Extension desk

Expansion stations greatly enhance the functionality and expandability of the phone. Each Expansion Station has 32 programmable keys (bi-color LEDs) and connects to IP Phones that support Expansion Stations via an TYPE-C straight-through cable. IP Phone supports up to 3 expansion stations and provides 96 programmable keys. In conjunction with IP-PBX, each programmable key can be used for speed dialing, BLF, and call answering in collaboration with the server.

The Extension Desk is suitable for front desk switchboards, administrative assistants, call center agents, and users who need to monitor or manage a large number of calls.

Product Information

parameters	clarification
keystrokes	32 programmable function keys with red and

	yellow-green LED bi-color LEDs.
Panel jam	32 handwritten notes.
Key Function	Speed dialing, call forwarding, call waiting, call pickup, BLF, DND.
connector	One Type-C data interface (IN), one Type-C data cascade interface (OUT), the maximum support for simultaneous cascade 6 expansion stations.
Maintenance	The main phone Web page maintains all data.
electric power source	No external power supply, powered by the telephone type-C cable.
operating temperature	0~60 °C.
relative humidity	10% to 90%.
sizes	174mm*100mm*35mm (L*W*H).
weights	0.25KG.

Extension table packing list

Open the box of the Expansion Console and carefully check whether the relevant accessories are complete against the packing list, which is shown below:

- 1 x Expansion Desk
- 1 TYPE-C Cable
- 1 metal mounting fastener (with 4 mounting screws)
- Extension table bracket

Connecting an Expansion Station

- Connects the handset to the extension station:

1. Connect the handset and the extension station through the metal mounting fasteners and secure them with the mounting screws.
2. Mounting bracket.
3. Use the TYPE-C cable (straight-through cable) to access the IN port of the

expansion station at one end, and the other to access the OUT port of the phone, as shown in the following figure:

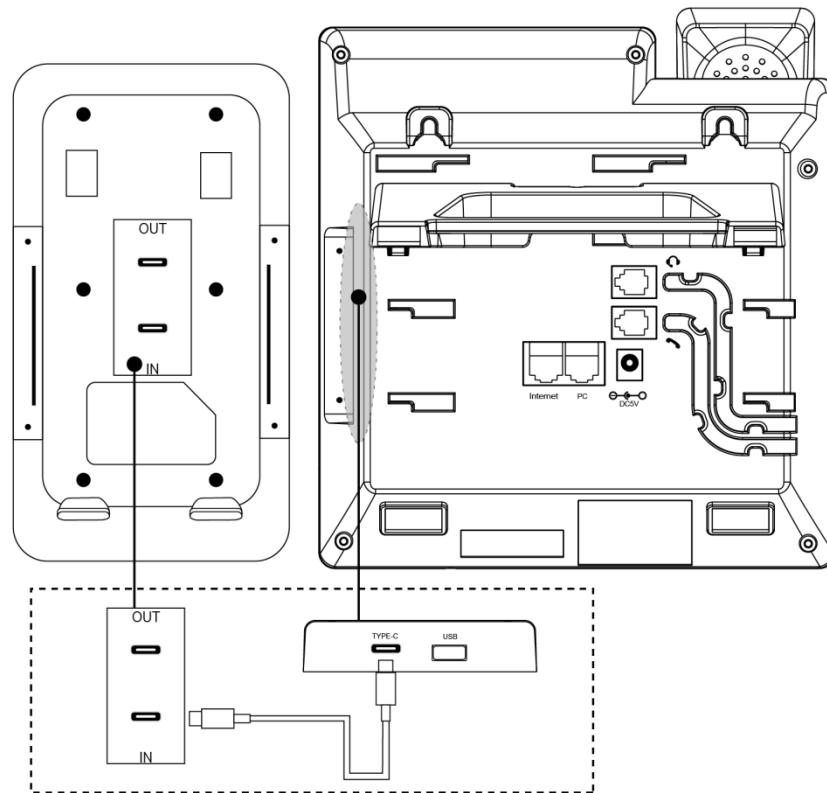

- Multiple expansion stations cascade:

1. Connect two or more expansion stations by metal mounting fasteners and install screws to fix them.
2. Mounting bracket.
3. Use an TYPE-C network cable (straight-through cable) to connect one end to the **OUT** connector of Expansion Station A and the other end to the **IN** connector of Expansion Station B. As shown in the figure below:

Description Up to 3 expansion stations can be connected. After connecting the extension station, you can set it up through the Web management interface of the phone.

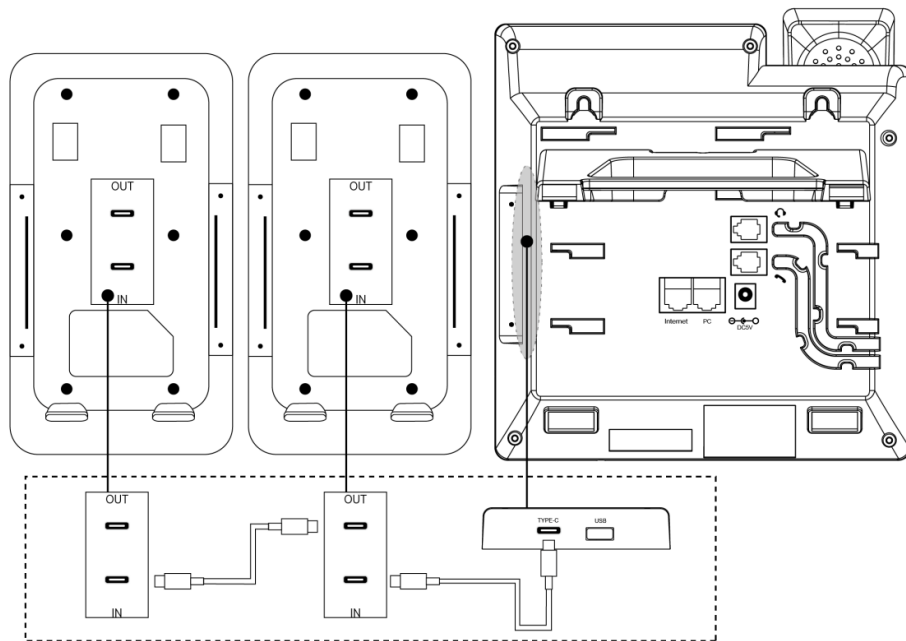

Expansion Table Hardware Overview

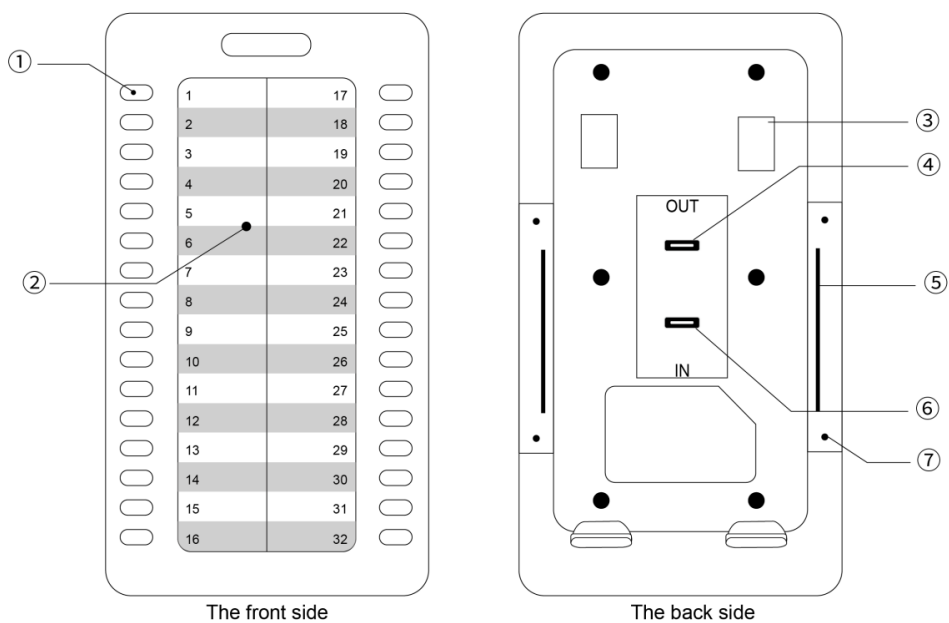

serial number	name	clarification
1	programmable key	Can be used to bind a speed dial number for speed dialing. It can be used to set certain function codes to work

		<p>with SIPServer to realize the function.</p> <p>When BLF* (Busy Line Detection) is turned on, you can check the busy and idle status of the corresponding number:</p> <p>1) Red color is always on: the remote line is talking.</p> <p>2) Flashing red: Incoming call on remote line.</p> <p>3) Yellow-green color is always on: Remote line idle**.</p> <p>Sequential programming of programmable keys:</p> <p>Left side from top to bottom: 1 to 16.</p> <p>Right side from top to bottom: 17 to 32.</p>
2	Extension table jam	Provides user identification definitions of the speed dial numbers and the function keys set up for easy access.
3	Bracket slot	Used to secure the extension table bracket.
4	OUT connector	Used for connecting to the IN port of the downlinked expansion unit.
5	Metal fastener slot	Metal fastener insertion position.
6	IN port	Used to connect to the OUT connector of a phone or to the OUT connector of an uplinked expansion station.
7	metal screw hole	Screw holes for mounting metal fasteners.



Test Expansion Station

[Connect the extension unit](#) After connecting the expansion unit, you can use the phone diagnostic function to check whether the keys and LEDs of the expansion unit are normal or not. If you want to set the key functions of the expansion unit, please go to the Web interface to configure them, and check the function description of the expansion unit for details.

For each connected station, you need to select the serial number of the station to

install, and through this process, the phone recognizes the serial number of the connected station. After successful installation, you can only check the status of the extension station in the Phone Status section of the web page.

– **Installation of the expansion table**

1. Operate on the phone, click **Menu->Functions->Expansion Disk Installation**, the screen displays "Press 1-3 of the expansion station to select the serial number,  button to finish".
2. At this time, all the keys on the expansion station that can select the serial number will light up yellow-green (1~3 keys from the left to the top to the bottom), and the key corresponding to the current serial number of the expansion station will light up red and blink, press the corresponding key, and the key will light up red and blink to determine or modify the serial number of the expansion station.
3. Press the  key or the **OK** softkey to submit the save.

– **Key Diagnostics**

1. To operate on the phone, click **Menu->Setup->Basic Settings->Diagnostics->Expansion Disk->Keypad**.
2. The screen will display the two-line string shown below:

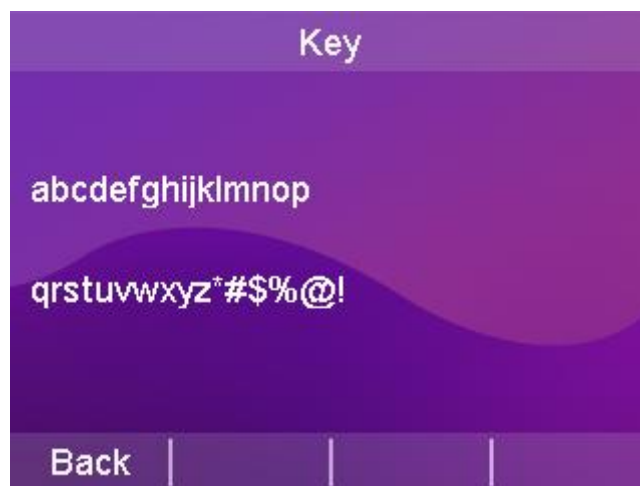

abcdefghijklmnop -----> Indicates keys 1-16 on the expansion disk.

qrstuvwxyz*#\$%@! -----> Indicates expansion disk keys 17-32

Tap the 32 keys on the expansion disk in sequence and the characters on the screen will disappear accordingly. If the corresponding characters on the screen do not disappear when a key is pressed, there is a problem with the key. If all the characters disappear, there is no problem with the 32 keys.

Instructions

1. If you detect that characters do not disappear when a button is pressed, please contact your network administrator or dealer for troubleshooting confirmation.
2. Repeat the above steps when connecting multiple expansion stations.

– Button LED Diagnostics

1. To operate on the phone, click **Menu->Settings->Basic Settings->Diagnostics->Expansion Disk->Light.**

2. The screen displays the following:



3. Cyclically press the  button, the LED of the expansion station will light up

DESCRIPTION For previous irregularities, please contact your network administrator or reseller for problem troubleshooting.

(multiple expansion stations will light up at the same time when cascading), red, yellow, and green, and observe whether the key LED is off, dim, and blinking without operation.

Extension Desk Functional Description

After installing the extension station (i.e., after setting the serial number for the extension station), you can set up operations for the keys on the extension station. Here, you can bind the key to a remote extension number for speed dialing; or set

it to some function code setting to realize some function with SIP Server. Of course, you may also need to apply the BLF* function of the keypad to view the call status of the corresponding remote extension.

- Web Setup Extension Desk

Configuration and status can be made easier and more convenient by setting up the Web page. When setting up the Web page, the following points must be determined:

- 1) Connect the computer and the IP phone with the extension desk to the same network. If there is no network interconnection device, you can connect the computer directly to the PC port of the IP phone through a straight-through cable.
- 2) Ensure that the phone has been operated properly and check the IP address of the phone.
- 3) Enter the phone IP address in the address bar of your browser.
- 4) Enter the administrator username and password to enter the webpage configuration page. The default administrator username is admin and the default password is admin.
- 5) Click "Programmable Keys" > "Extension Desk" in the left navigation bar to open the Extension Desk settings page.

As shown:

Key	Type	Account	Label	Value	Extension
Line Key1	BLF	Account1	123	0035	
Line Key2	BLF	Account1		0021	
Line Key3	BLF	Account1		0022	
Line Key4	BLF	Account1		0023	
Line Key5	BLF	Account1		0021	
Line Key6	BLF	Account1		0026	
Line Key7	BLF	Account1		0029	
Line Key8	BLF	Account1		0030	
Line Key9	BLF	Account1		0031	
Line Key10	BLF	Account1		0032	
Line Key11	BLF	Account1		0033	
Line Key12	BLF	Account1		0034	
Line Key13	BLF	Account1		0035	
Line Key14	BLF	Account1		0036	
Line Key15	BLF	Account1		0037	

- Setting up the expansion table

1. Select the expansion station n you need to configure.
2. Select the keys you need to configure (refer to the Expansion Console

Overview - Keys and Hardware section for the specific key sequence).

3. Select each parameter to set and modify:

* :: Type: Select the function of the account.

* Account: Select the SIP account associated with this key.

* Label: sets the name description of the key.

* :: Value field: sets the key to carry out dialing a number or a function code that realizes a function of a platform.

* :: Extension number: Fill in the feature code supported by the server on demand, depending on the type.

Refer to the programmable keys for parameter settings of the function.

4. Tap the **Submit** button to save.

System Customization



Account Management

The phone can register SIP accounts, up to four accounts, and make calls through the registered SIP accounts. Four accounts can be used to make multiple calls at the same time, by pressing the account key to switch the account used.

Account Registration



- Register for an account through the phone interface

1. Press **Menu->Settings->Advanced Settings (Password:admin)->Account**.

2. Press  or  to select the account to be configured and press the

Enter soft key to enter the configuration screen.

3. Account status can be enabled or disabled by **toggling the** softkey.

4. Press  or  to select the label, display name, user name, registration name, password, server address, and Registration server port.

5. Change the transmission mode by **switching the** softkey: UDP or TCP.

6. Press the **Save** soft key to save the account.



SIP Line		
1.Active Line:	enable 	
2.Label:	28006	
3.Display Name:	28006	
4.Register Name:	28006	
5.User Name:	28006	
Back	Switch	Save

- Registering for an account through the web interface

1. Log in to the phone page by IP address.

2. Click **Account (A) -> Register (r)**.

3. Fill out and **submit** (required fields: user name, registered account, password, server address, port).

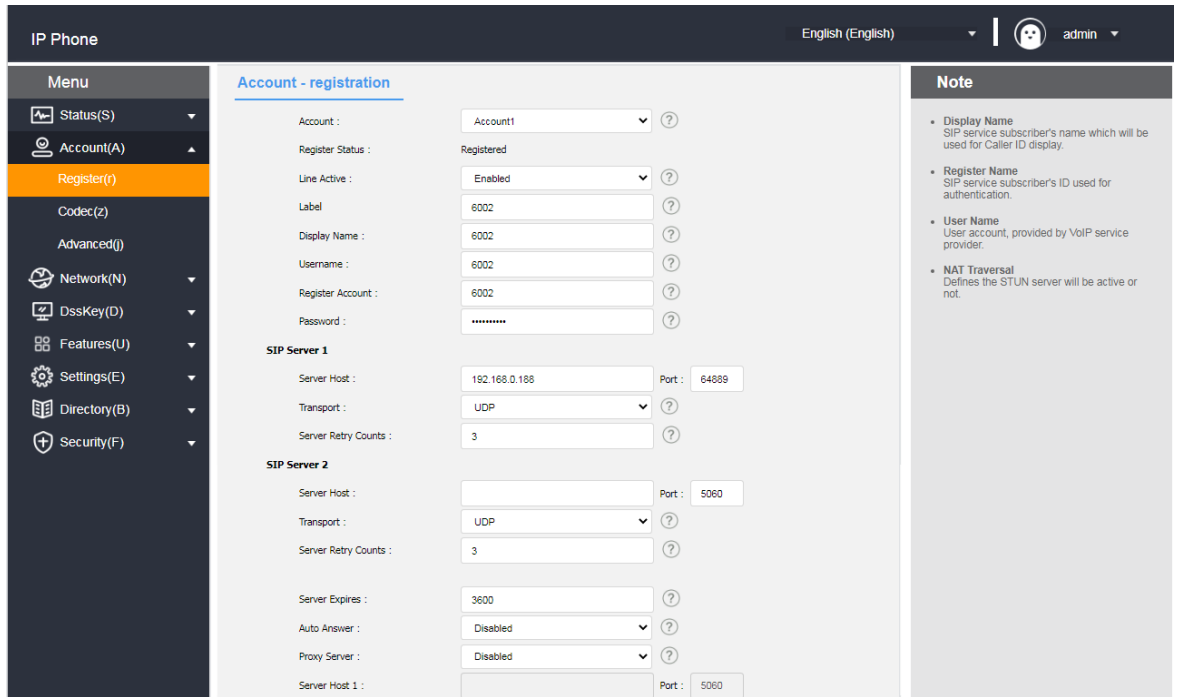

- Configuration of codecs through the web interface

1. Log in to the phone page by IP address.
2. Click **Account (A)** -> **Codec (z)**.
3. Select the codec to be enabled and then **submit it** (support type: PCMA/PCMU/G722/G729/G726, etc.).

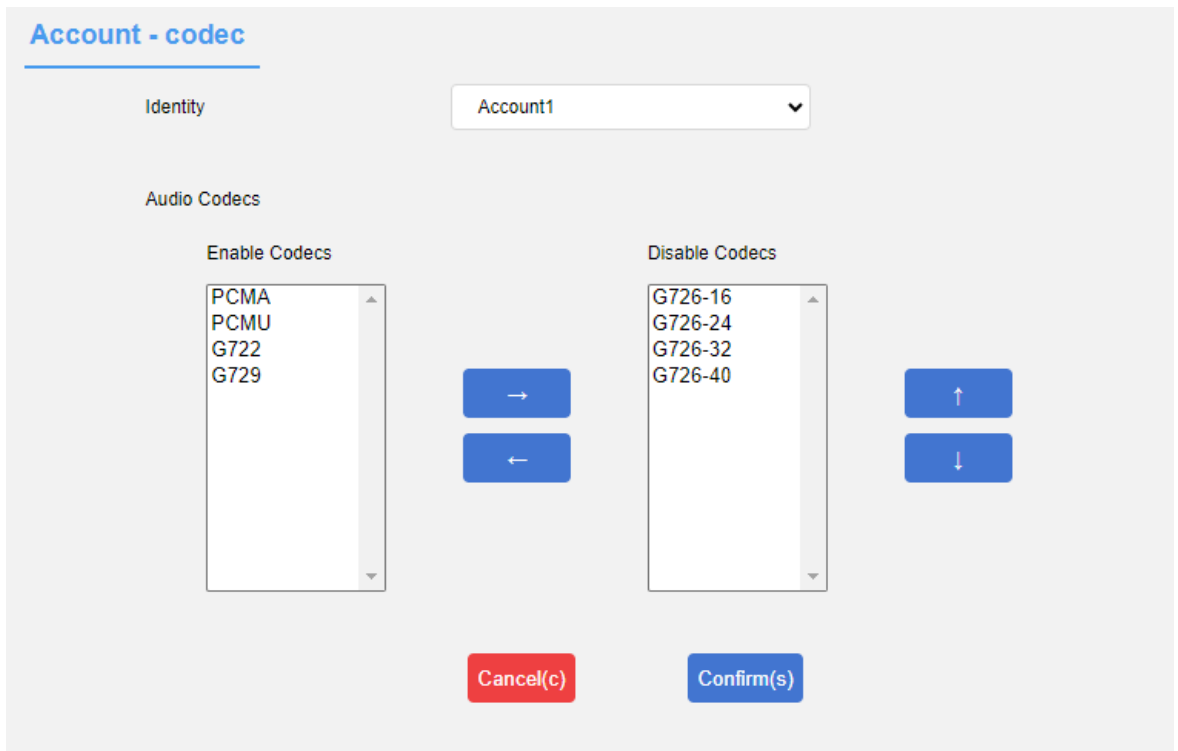



-Configure IP Direct dial codec on the web page

1. Log in to the phone page using the IP address.

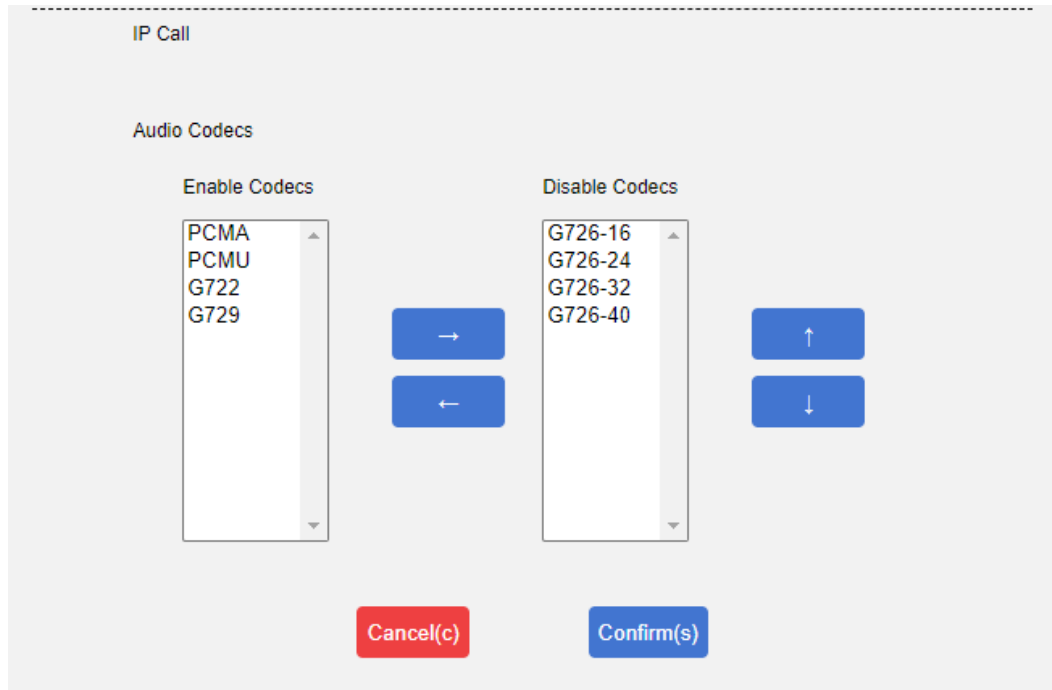
-
2. Click Account (A) -> Codec (z).
 3. Select the Codec to be enabled and submit it (Support type: PCMA/PCMU/G722/G729/G726, etc.).



- Configuration of codecs through the phone interface

1. Press **Menu**->**Settings**->**Advanced Settings** (password:admin)->**Account Advanced**->**Codec**.
2. Press  or  to select the codec input value to be configured, the higher the value the higher the codec priority.
3. Press the **Save** soft key to save.

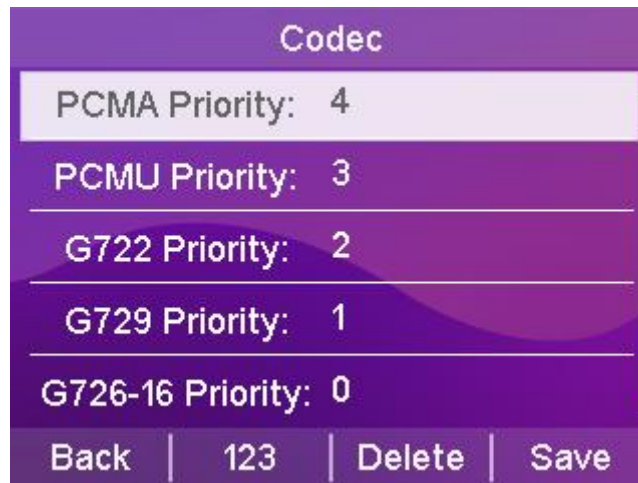

Explanation If there is a problem that the phone can not be registered, please check whether the registered information is filled in correctly, check whether the network of the phone is normal, if you need help, please contact your network administrator.





Programmable keys

Divided into account keys, [Expansion Station keys](#), and programmable function keys.

Account key

The phone has four account keys located on the right side of the LCD display. You can set different functions for each of the four keys, and you can set a label for the account key, which will be displayed on the LCD display corresponding to the account key when the phone is in standby.

- Setting the account key function through the phone interface

1. Press **Menu->Features->Programmable Keys**.
2. Press  or  to select the account key to be changed.
3. Press the **Toggle** key to change the type selection.
4. Press  or  to select a label/username to fill in.
5. Press the **Save** soft key to save.

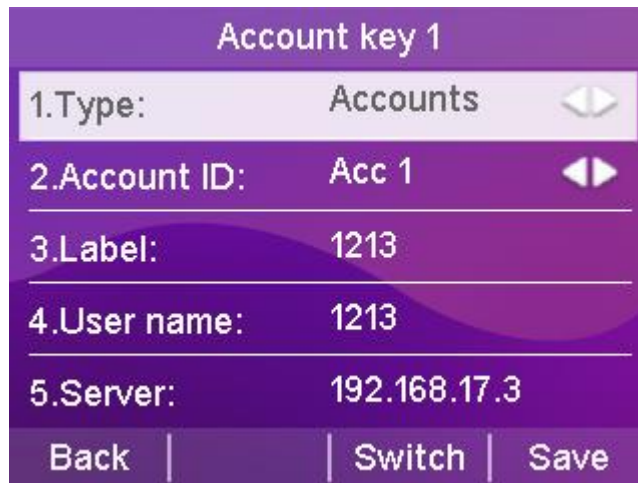

- Setting up account key functions through the web interface

1. Log in to the phone page by IP address.
2. Click the **programmable key (D) -> account key (w)**.
3. Select different functions in the type selection.
4. Number Fill in the called number, the filled in label will be shown on the right side of the LCD in standby.
5. Press **Submit** to save when you have finished selecting.

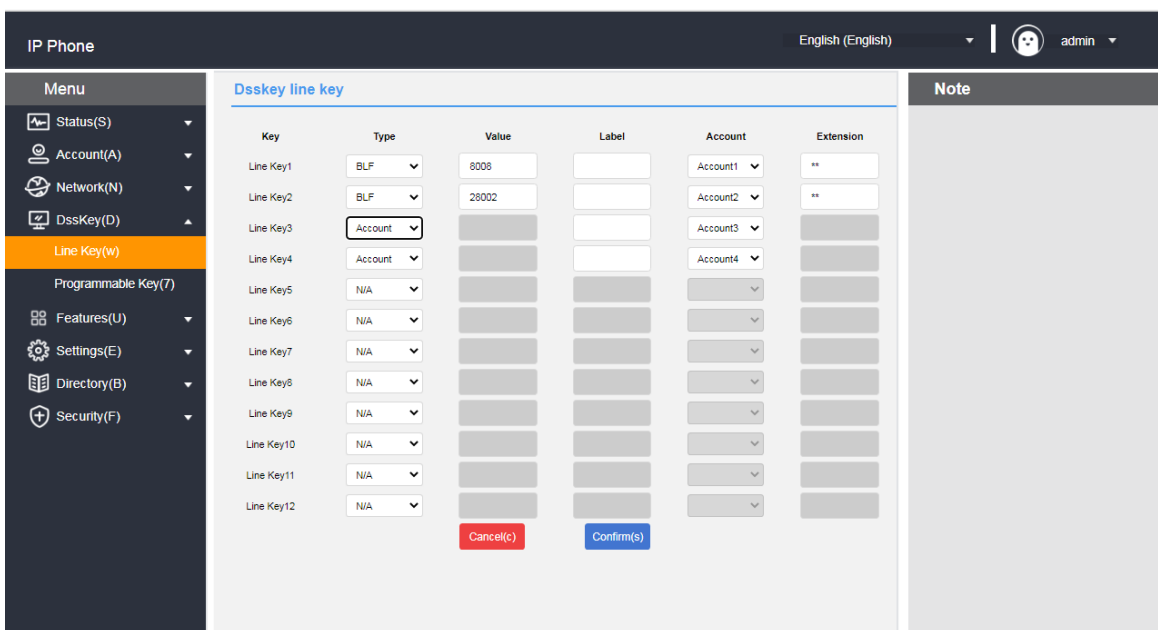

Account Key Function Type Description

	typology	Instructions and use
account number key	Account	<p>The system defaults to the account key.</p> <p>- Usage:</p> <ol style="list-style-type: none"> 1. Set the account type to "Account". 2. The number does not need to be filled in. 3. Set up labels on demand. 4. Click on the account number key, the key's green light is always on and a dial tone is emitted, prompting the user to dial the number.
	walkie-talkies	<p>After setting up the intercom, press the account number button to automatically dial the set number to realize intercom.</p> <p>- Usage:</p> <ol style="list-style-type: none"> 1. Set the account type to "Walkie Talkie". 2. Number Fill in the number of the intercom to be carried out. 3. Set up labels on demand. 4. The other party's phone needs to be set to answer automatically. 5. Click the Account button to automatically dial to the set number. 6. The handset of the called number automatically answers the intercom call. <p>For details, please refer to Features Walkie Talkie for a detailed description.</p>
	key event	<p>-Key Type</p> <ol style="list-style-type: none"> 1. Call Parking: Park the call at the PBX designated parking space by feature code. <p>-value fills in the call park feature code.</p>

		<p>2. Callback: Quickly dial the number of the last incoming call.</p> <p>3. DND: Same as the initial interface DND.</p> <p>4. DTMF: Quickly enter pre-configured DTMF content during a call. -value Fill in the DTMF content you want to configure.</p> <p>5. Address Book: Same function as the initial interface of Address Book.</p> <p>6. Group listening: handle and hands-free simultaneous radio, handle can speak, hands-free can not speak.</p> <p>7. Group Intercept: Intercepting (answering on behalf of) calls within the same group by means of a feature code. -Account ID selects the intercept account -Value Fill in Group Intercept Code</p> <p>8. Hold: Same as hold in a call.</p> <p>9. Local Groups: Quickly jump to the specified groups. -Local Groups Specify Groups to Jump to</p> <p>10. Multicast: Quickly initiate a multicast. -value Fill in the multicast address IP + port number. -Channel selects one from 0-30</p> <p>11. Multicast List: Quickly jump to Menu→Function→Multicast List interface.</p> <p>12. Specify Intercept: Specify intercept the call by designated pickup feature code. -When the specified intercept is not enabled on the web side, fill in the intercept code + extension number; otherwise, fill in the extension number.</p> <p>13. Prefix: Quickly enter a pre-configured prefix for easy dialing. -value Fill in the prefix to be configured</p> <p>14. Text Message: Quickly jump to Menu→Information→Text Message interface.</p>
--	--	---

		<p>15. Call Forwarding: Quickly forward calls to a specified number.</p> <p>-value for the forwarding number</p> <p>16. Voice message: the same SMS key, set the voice feature code or speed dial the voice feature code to listen to the voice message.</p> <p>-Account ID selects the specified account</p> <p>-value fill in voice feature code</p> <p>17. XML Browsing: Browse XML in accordance with the specified format, support for browsing text, images, address book and so on.</p> <p>-value fill in XML browser address</p> <p>18.XML Groups: Quickly jump to a specified remote address book.</p> <p>-XML group fill in the name of the remote address book, you need to have data in the remote address book before use.</p> <p>19. Keypad Lock: When the keypad lock is activated, press to quickly lock.</p> <p>20. Hot desking: Clear the current account configuration and enter a new account password to quickly configure the phone.</p>
	retrieve a call parked call	<p>Retrieve calls parked at the PBX's designated moorings by feature code.</p> <p>- Usage:</p> <ol style="list-style-type: none"> 1. The account type is set to "Retrieve park". 2. Account ID sets the call account. 3. Set up labels on demand. 4. The value is filled with the corresponding feature code of the server. 5. Click on the account button to get the call back via the feature code.
	speed dial	Quickly dial the designated account number.

		<p>- Usage:</p> <ol style="list-style-type: none"> 1. The account type is set to "Speed Dial". 2. Account ID sets the account number for dialing out. 3. Set up labels on demand. 4. The value is filled in with the other party's number. 5. Click the account number key, the green light corresponding to the dialed out account always light up and emit a dial tone.
	BLF	<p>Used to monitor the working status of other phone numbers and call pickup.</p> <p>- Usage:</p> <ol style="list-style-type: none"> 1. Set the account type to "BLF". 2. Account ID Select the number you want to call. 3. Set up labels on demand. 4. The value is the number to monitor or intercept. 5. Extension number can be selected to fill in or not, <p>when you need to intercept the call, fill in the server specified intercept code.</p> <p>When the green light is always on, clicking the account number key is equivalent to speed dialing;</p> <p>When the red light is blinking, if you set the intercept code, you can make a call on behalf of the call by clicking the account button at this time.</p> <p>A red light is always on to indicate that the listening number is in a call.</p>

Programmable Function Keys

You can customize the functions of the soft keys, arrow keys, and functional buttons below the screen for the phone according to your personal habits.

- Programmable function keys via web interface

1. Log in to the Web interface.
2. Click **Programmable Key (D)** -> **Programmable Function Key (7)**.
3. Softkey 1 ~ Softkey 4 set the label content, which can be displayed on the LCD screen.

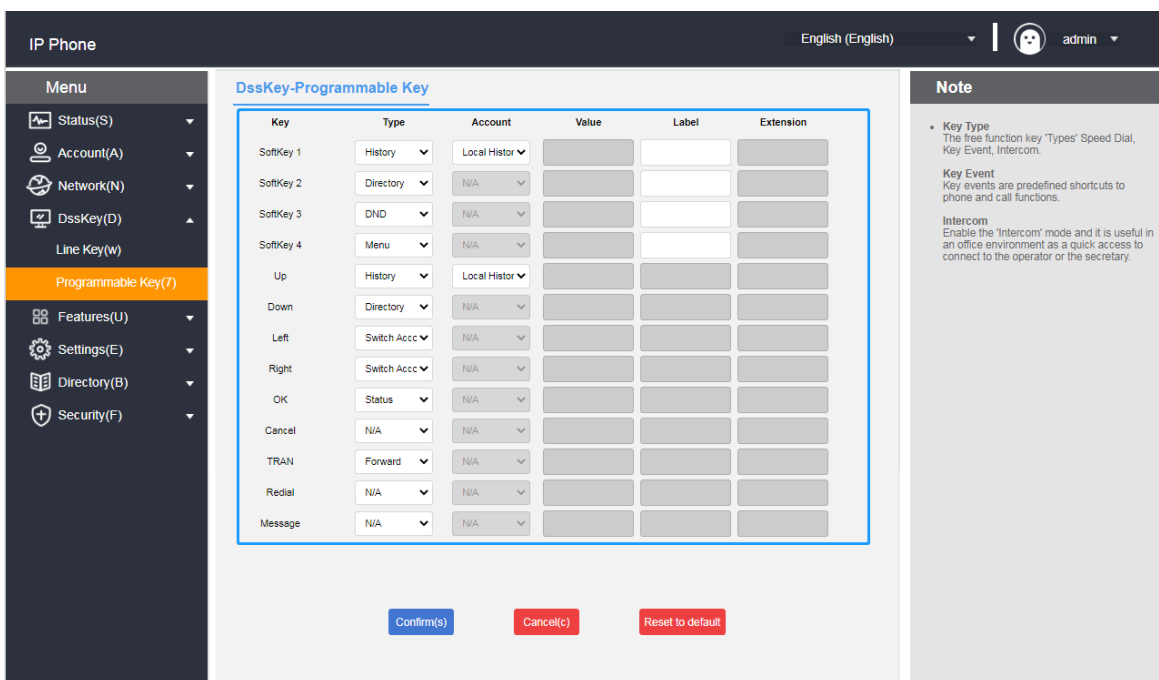

4. Click the **Submit** button to save.

Description Programmable function keys are set in the web interface. If there is a problem with the settings, you can click Restore Defaults to restore all keys to their factory state.

Programmable Function Key Type Description

	typology	Instructions and use
Programmable Function Keys	unoccupied	/
	speed dial	<p>Quickly dial the designated account number.</p> <p>- Usage:</p> <ol style="list-style-type: none"> 1. Set the type to "Speed Dial". 2. The account is set to the corresponding account that needs to realize speed dialing. 3. The value field is set to the

		<p>number of the other party.</p> <ol style="list-style-type: none"> 4. Set up labels on demand. 5. Pressing after setting will speed dial the set number.
	group pickup	<p>Setting up group interception allows you to intercept accounts in the same interception group.</p> <p>- Usage:</p> <ol style="list-style-type: none"> 1. Set the type to "Group Intercept". 2. The account is set to the corresponding account that needs to realize the group interception. 3. The value field is set to the group intercept feature code. 4. Set up labels on demand. 5. When there are accounts in the Intercept Group in the incoming call status, press the Group Intercept key to realize group interception.
	walkie-talkies	<p>After setting up the intercom, pressing the account button will automatically dial the set number to realize intercom.</p> <p>- Usage:</p> <ol style="list-style-type: none"> 1. Set the type to "Walkie Talkie". 2. AccountFill in the account to be intercom. 3. The value field is set to Intercom Prefix + the number of the other party to be intercomed. 4. Set up labels on demand. 5. Click the Account button to automatically dial to the set number. 6. The handset of the called number automatically answers the intercom call. <p>For details, refer to the detailed description of the function intercom.</p>
	prefix	<p>Quickly enter pre-configured prefixes for easy dialing.</p> <p>- Usage:</p> <ol style="list-style-type: none"> 1. Set the type to "Prefix". 2. The value field is set to the value you want to configure. 3. Set up labels on demand. 4. Pressing after setting will bring up the dialing screen with the prefix value.
	local group	<p>Quickly jump to a specific group.</p> <p>- Usage:</p>

		<ol style="list-style-type: none"> 1. Set the type to "Local Group". 2. The account selects the group you need to jump to. 3. Set up labels on demand. 4. Pressing after setting will quickly jump to the designated group.
	XML Browsing	<p>Browsing XML that conforms to a defined format, with support for browsing text, images, address books, etc.</p> <p>– Usage:</p> <ol style="list-style-type: none"> 1. Type is set to "XML Browser". 2. The value field is filled with the XML browser address. 3. Set up labels on demand. 4. After setting up press will browse the related XML.
	Designated pickup	<p>You can intercept a specified account after you set a specified intercept.</p> <p>– Usage:</p> <ol style="list-style-type: none"> 1. Set the type to Specified Intercept. 2. Set the account to the account that you want to intercept. 3. Set the value range to the specified truncated feature code + account. 4. Set labels as required. 5. When the specified account is in the incoming call state, press the specified intercept key to intercept the call.
	History	<p>You can go directly to the call log page after setting up call log.</p> <p>– Usage:</p> <ol style="list-style-type: none"> 1. Set the type to "History". 2. The account defaults to the local call record. 3. Set up labels on demand. 4. Pressing this key takes you directly to the call log.
	menu	<p>– Usage:</p> <ol style="list-style-type: none"> 1. Set the type to "Menu". 2. Set up labels on demand. 3. Pressing the key takes you directly to the menu.
	Forward	<p>– Usage:</p> <ol style="list-style-type: none"> 1. Set the type to "Transfer". 2. Set up labels on demand. 3. Press the key for the first time to enter the page of setting the unconditional transfer number, and set it as the unconditional transfer

		switch.
	distraction-free	<ul style="list-style-type: none"> - Usage: <ol style="list-style-type: none"> 1. Set the type to "Do not disturb". 2. Set up labels on demand. 3. Set it up as a do-not-disturb switch.
	Call back	<ul style="list-style-type: none"> - Usage: <ol style="list-style-type: none"> 1. Set the type to "Callback". 2. Set up labels on demand. 3. Set up for the callback button.
	SMS	<p>Quickly jump to the Menu→Information→Text Message screen.</p> <ul style="list-style-type: none"> - Usage: <ol style="list-style-type: none"> 1. Set the type to "SMS". 2. Set up labels on demand. 3. After setting, press will jump to the text message interface.
	new SMS	<p>Quickly jump to Menu → Messages → Text Messages screen → New Message.</p> <ul style="list-style-type: none"> - Usage: <ol style="list-style-type: none"> 1. Type is set to "New SMS". 2. On-demand labeling 3. After setting, press will jump to the new message editing interface.
	Status	<ul style="list-style-type: none"> - Usage: <ol style="list-style-type: none"> 1. Set the type to "Status". 2. Set up labels on demand. 3. After setting up, press to check the status of the phone.
	multicast	<p>Quickly initiate a multicast.</p> <ul style="list-style-type: none"> - Usage: <ol style="list-style-type: none"> 1. Set the type to "Multicast". 2. The value field is filled with the multicast address IP + port number. 3. Set up labels on demand. 4. Extension number fill in the channel number. <p>Please refer to the detailed description of the function multicast configuration for more information.</p>
	local contact	<ul style="list-style-type: none"> - Usage: <ol style="list-style-type: none"> 1. Set the type to "Local Contact". 2. Set up labels on demand. 3. Press to enter local contacts after setting.
	Hot desking	<p>Clear the current account configuration Enter a new account password to quickly configure the phone.</p> <ul style="list-style-type: none"> - Usage: <ol style="list-style-type: none"> 1. Type set to "Hot desking"

		<ol style="list-style-type: none"> 2. Set up labels on demand. 3. After setting up and pressing will prompt whether to clear all account configurations.
	Keypad lock	<p>Keys are locked when keypad lock is enabled.</p> <p>- Usage:</p> <ol style="list-style-type: none"> 1. Set the type to "Keylock" 2. After setting the keyboard, press it to prompt: The keyboard is locked.- <p>Usage:</p>
	Switching Accounts Upwards	<p>- Usage:</p> <ol style="list-style-type: none"> 1. Set the type to "Upward account switching". 2. Set up labels on demand. 3. After setting up, press the key to switch the default account upwards.
	Switching Accounts Down	<p>- Usage:</p> <ol style="list-style-type: none"> 1. Set the type to "Downward account switching". 2. Set up labels on demand. 3. Press the key to switch the default account down after setting.
	Directory	<p>- Usage:</p> <ol style="list-style-type: none"> 1. Set the type to "directory". 2. Set up labels on demand. 3. Press the key to enter the directory after setting.
	Multicast list	<p>Quickly jump to the Menu→Functions→Multicast List screen.</p> <p>- Usage:</p> <ol style="list-style-type: none"> 1. Type is set to "Multicast List". 2. Set up labels on demand. 3. Press after setting will enter the multicast list interface.
	Change page	<ol style="list-style-type: none"> 1. Set the type to Change page. 2. Set labels as required. 3. Press this key to turn the page of the account. 4. Note: It is only used in Line Key page-turning mode. The setup method:Click Settings → Priority on the web page and set Line Key page-turning mode to use programmable keys;
	Switch left	<p>Toggle left desktop default quick access options.</p> <p>- Usage:</p> <ol style="list-style-type: none"> 1. Set the type to "Switch left" 2. Set labels as required.

		3. After the Settings are set, press to switch to the left menu of the standby screen.
	Switch right	<p>Toggle the desktop default quick access option to the right.</p> <p>- Usage:</p> <ol style="list-style-type: none"> 1. Set the type to "Switch Right" 2. Set labels as required. 3. After the Settings are set, press to switch right to the menu option on the standby screen.
	Enter selected	<p>Quickly jump to the specified menu option.</p> <p>- Usage:</p> <ol style="list-style-type: none"> 1. Set the type to Enter. 2. Set labels as required. 3. After the Settings are complete, switch the menu options left and right to select the menu you want to enter. Press it to enter the corresponding interface.

Dialing Rules

Setting up dialing rules allows the phone to dial conveniently according to the syntax set up by the dialing rules.

Description This function can only be set in the web interface.

Dialing Rule Syntax

Before using dialing rules, you need to understand the dialing syntax; if you are already familiar with that syntax, you can skip this step and check the [Dialing Rules](#)

[Feature](#) Content.

Dialing Rule Symbol Description:

character	clarification	(for) instance
.	Indicates any number of placeholders	Enter "78." Match "786", "7856", "78911", "7857713", etc.

x	Indicates a placeholder	Enter "78x" Match "781," "782," "783," "784." ... "789", etc.
-	Indicates an interval range	Enter "[7-9]". Match "7" or "8" or "9".
[]	Indicates an interval range, there is only one [] in the string, use it with the - symbol.	Enter "12[7-9]45". Match "12745," "12845," "12945."
()	Indicates multiple interval range combinations with multiple [] in the string	Enter "([1-2][7-8])". Match "17," "27," "18," "28."

DESCRIPTION For questions about the syntax and use of dialing rules, contact your network administrator.

Dialing Rules Feature

Dialing rules include the following:

- Replacement rules
- Call out immediately
- Area code
- Restriction of outgoing calls

1) Replacement rules

You can customize the replacement rules up to 100. Replacement rules mean that you can enter a string of characters and the phone will automatically replace it with your customized string. In practice, for example, if you set a substitution rule to input "1" and replace it with "10086", when you dial 1 on the phone and press the Send softkey or #, the phone will automatically replace it with 10086 for dialing.

Using substitution rules, you can also make quick IP point-to-point calls.

- Adding replacement rules through the web interface

1. Log in to the phone page by IP address.
2. Click **Settings (E) -> Dialing Rules (k) -> Replace Rules.**
3. Enter a string in the **Prefix** field (e.g., 1).
4. Enter the replacement string (e.g., 10086) in the **Replacement** area.
5. Select the lines to which the rule applies at the **account number** (where all indicates all lines).
6. Click the **Add** button to save the rule.

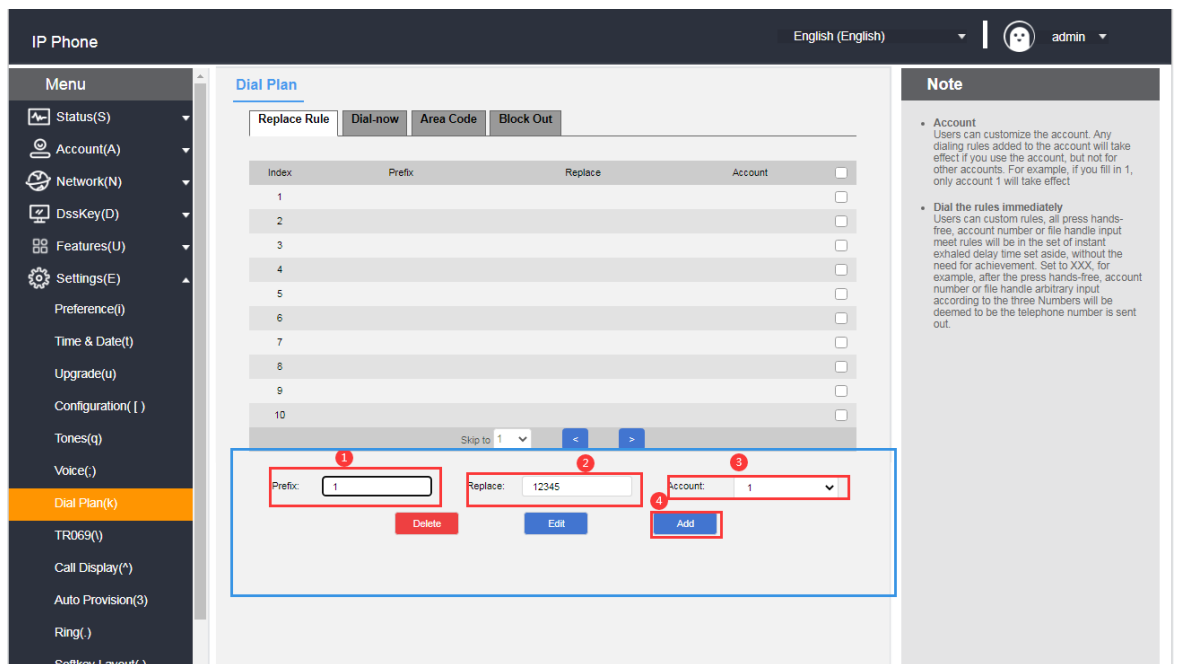

After adding the above rules, when you dial the number "1", press the **Send** soft key or # to call, the phone will automatically replace the number with "10086" for dialing.

- Modification of replacement rules through the web interface

1. Log in to the phone page by IP address.
2. Click **Settings (E) -> Dialing Rules (k) -> Replace Rules**
3. Check the checkbox to the right of the rule you want to modify in the rule list.
4. Modify **prefixes/replacements/accounts** as needed.
5. Click the **Edit** button to save the changes.

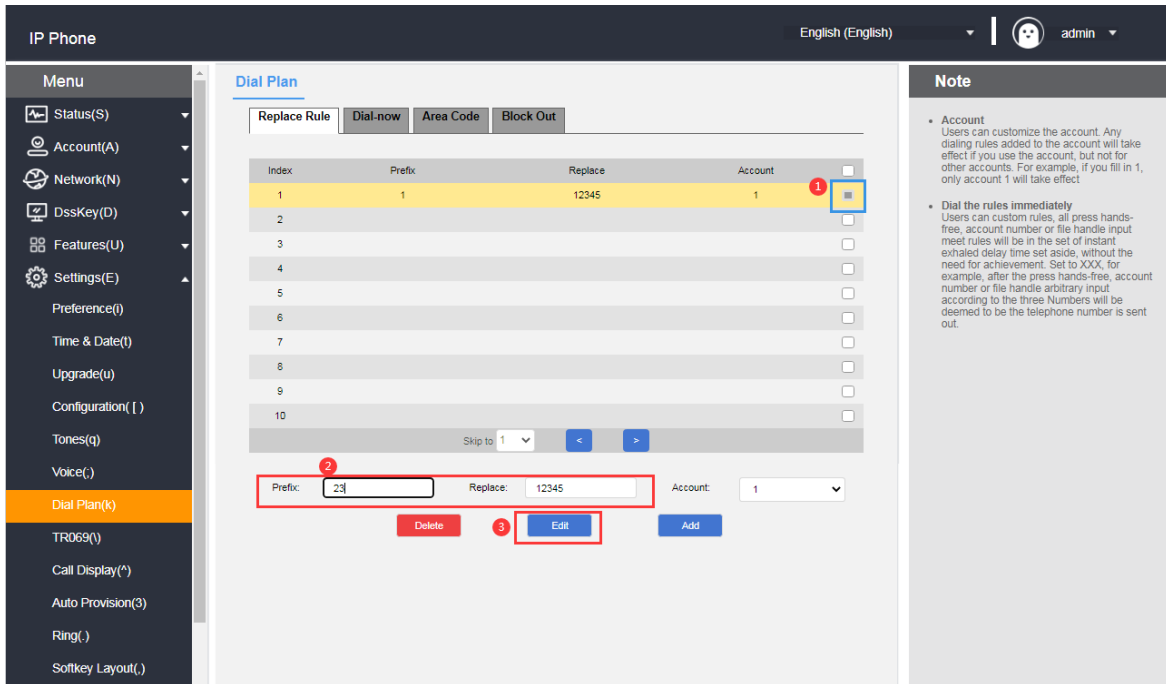

- Deletion of replacement rules through the web interface

1. Log in to the phone page by IP address.
2. Click **Settings (E) -> Dialing Rules (k) -> Replace Rules**.
3. Check the checkbox to the right of the rule you want to modify in the rule list.
4. Click the **Delete** button to delete the rule.

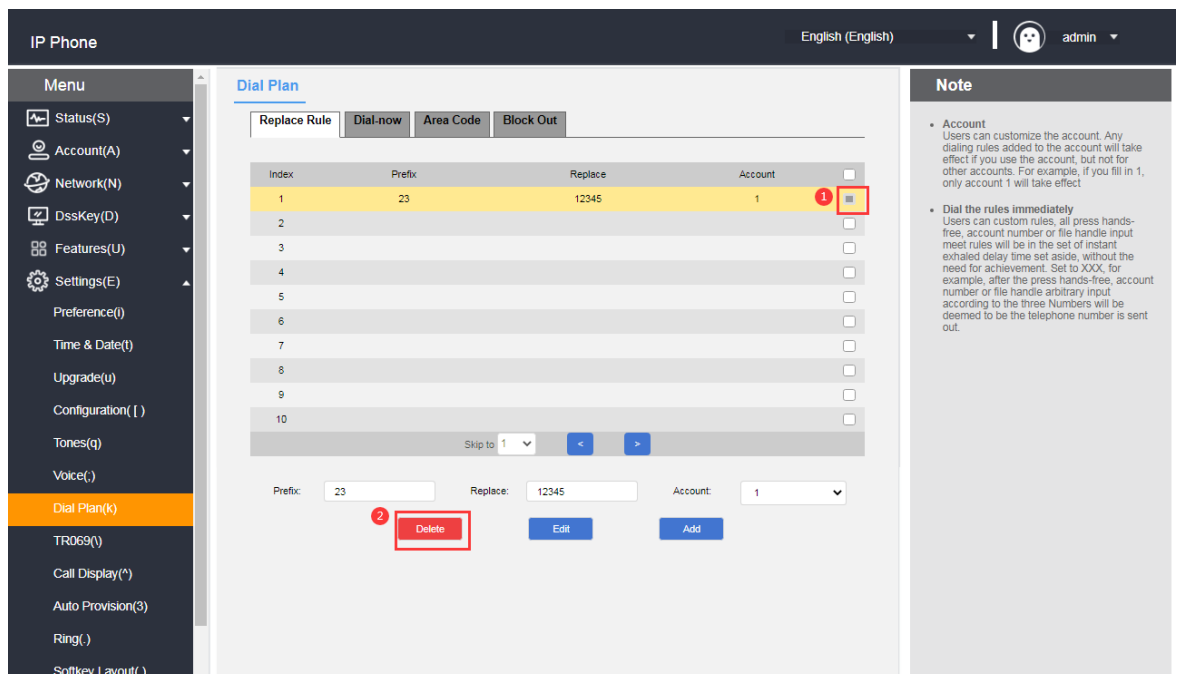

2) Exhale immediately

You can customize the immediate outgoing rules, up to 100 rules, all the numbers that meet the rules by pressing the speakerphone, account number key or lifting the handle will be dialed in the set immediate outgoing delay time, without

pressing the send key. For example, when you set the call out rule as xxxxxx, the caller account number is all (any account), when you dial any five-digit number of 10086, the phone will call 10086 immediately when you meet the call out rule.

- Adding immediate callout rules through the web interface

1. Log in to the phone page by IP address.
2. Click **Settings (E)** -> **Dialing Rules (k)** -> **Call Out Now**.
3. Enter the rule characters to be set in the rule input area (e.g.: xxxxxx).
4. Account selects the account to which the matching rule applies (e.g., the current registered account 8001), and the default value is all (indicating all accounts).
5. Click the **Add** button to save the rule.

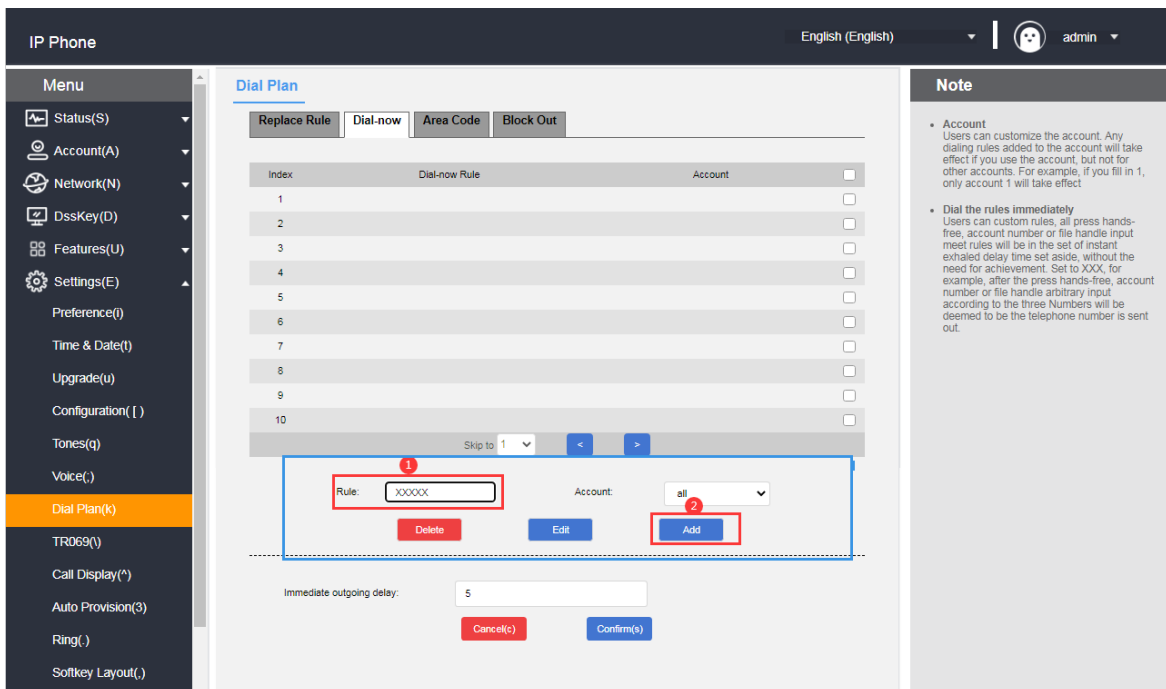

When any five-digit number such as 10086 is entered, it will be called out immediately after waiting for the delay time.

- Modify the immediate callout rules through the web interface

1. Log in to the phone page by IP address.
2. Click **Settings (E)** -> **Dialing Rules (k)** -> **Call Out Now**.

3. Tap the rule you want to modify in the rule list.
4. Modify the rule in the rule input area, e.g.: (original: xxxxx --> change: 1xxxx).
5. Account area to select the account to which the matching rule applies (e.g., the current registered account 8001), the default value is all (indicating all accounts).
6. Click the **Edit** button to save the modified rule.

The screenshot displays the 'Dial Plan' configuration interface. The table below represents the data shown in the interface:

Index	Dial-plan Rule	Account
1	XXXXX	all
2		
3		
4		
5		
6		
7		
8		
9		
10		

The 'Edit' form below the table shows:

- Rule: 1XXXXX
- Account: all

Buttons: Delete, Edit, Add, Cancel(c), Confirm(s)

Immediate outgoing delay: 5

Note:

- Account**
Users can customize the account. Any dialing rules added to the account will take effect if you use the account, but not for other accounts. For example, if you fill in 1, only account 1 will take effect.
- Dial the rules immediately**
Users can custom rules, all press hands-free, account number or file handle input meet rules will be in the set of instant exhaled delay time set aside, without the need for achievement. Set to XXX, for example, after the press hands-free, account number or file handle arbitrary input according to the three Numbers will be deemed to be the telephone number is sent out.

- Remove immediate callout rules through the web interface

1. Log in to the phone page by IP address.
2. Click **Settings (E) -> Dialing Rules (k) -> Call Out Now**.
3. Tap the rule you want to delete in the Rule List.
4. Click the Delete button to delete the rule.

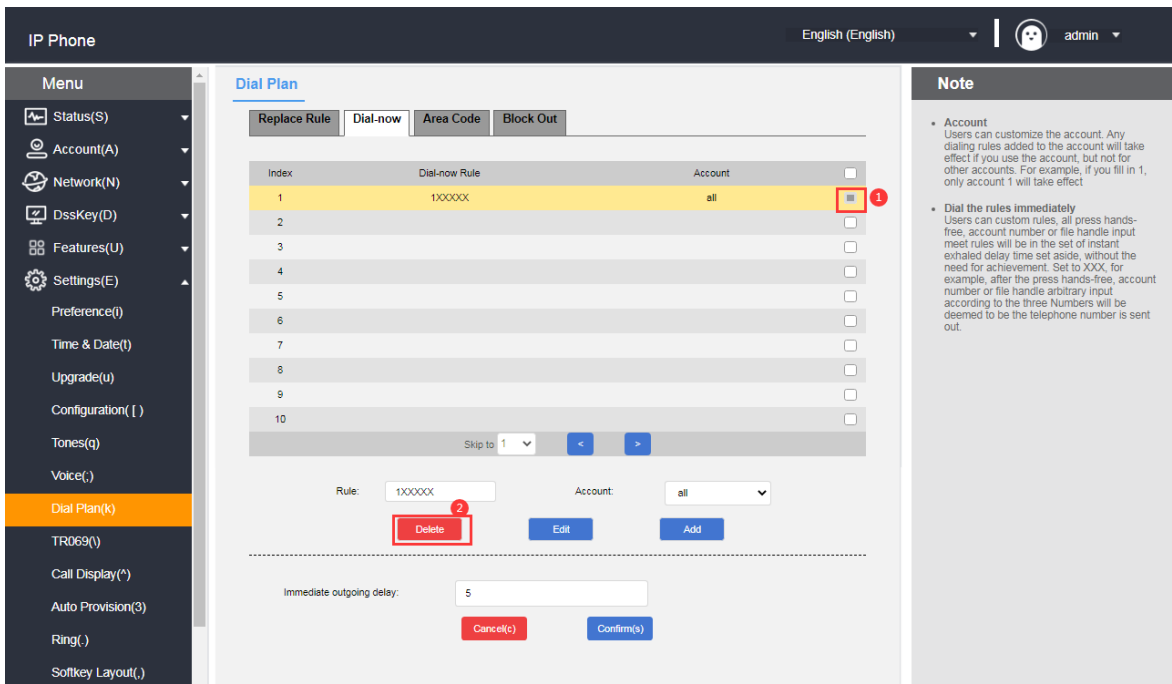

Immediate outbound delay time

Immediate call out needs to set the delay time, the default time is 2 seconds, the setting range is 0~14 (unit: second), when the number entered when dialing meets one of the immediate call out rules, the phone will automatically call out the number after the delay time, without pressing the send key.

- Setting the delay time for immediate outgoing calls through the web interface

1. Log in to the phone page by IP address.
2. Click **Settings (E)** -> **Dialing Rules (k)** -> **Call Out Now**.
3. In the Instant Callout Delay entry field, fill in the time.
4. Click the **Submit** button to save.

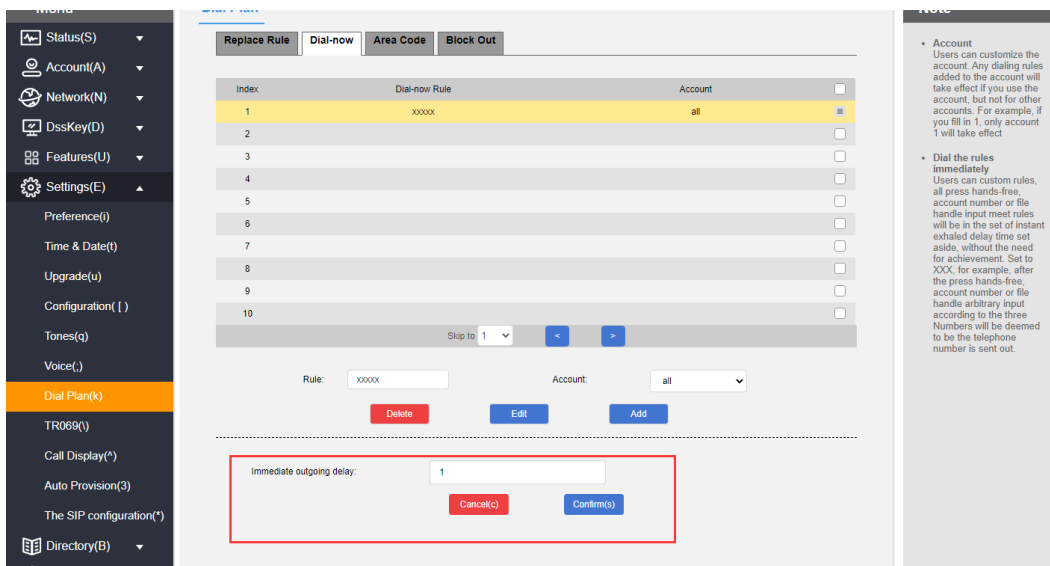

3) Area code

You need to add the area code to make calls between different regions, which are different from one region to another. If you need to call a phone number in a certain area frequently, you need to manually dial the area code prefix of that area. Use this feature to automatically add the area code/prefix in front of your outgoing number.

Description Only one area code can be set for the phone.

Example:

Setting the area code (length range: 1~15 digits)	0757
When you dial the number (length range: 1~15 digits))	12345
The actual outgoing number is changed to	075712345

- Setting up area codes through the web interface

1. Log in to the phone page by IP address.
2. Click **Settings (E) -> Dialing Rules (k) -> Area Code**.
3. Fill in the area code (length range: 1~15 digits).
4. The account number can be filled in with the registered account of the matching area code or the default value is all (all accounts).

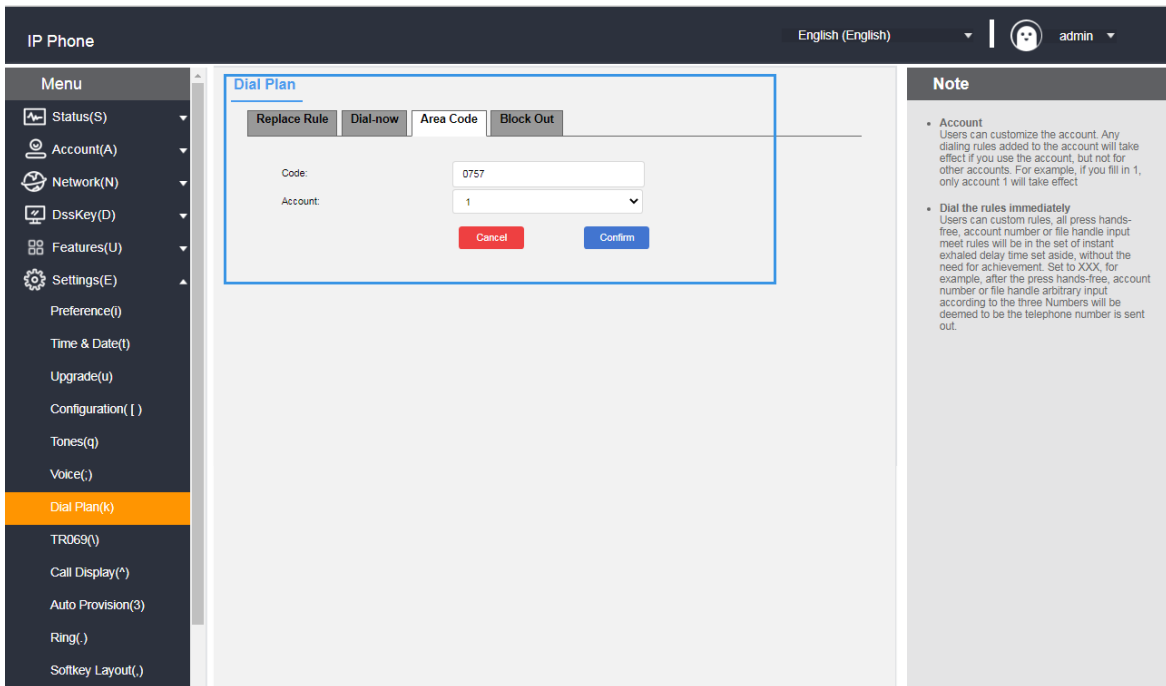

4) Restriction of outgoing calls

You can restrict the phone from dialing certain numbers by setting outgoing number restrictions, and the IP Phone supports up to 10 restricted calls.

When the number you are calling matches the rule, the word "Forbidden Number" will be displayed on the LCD of the phone.

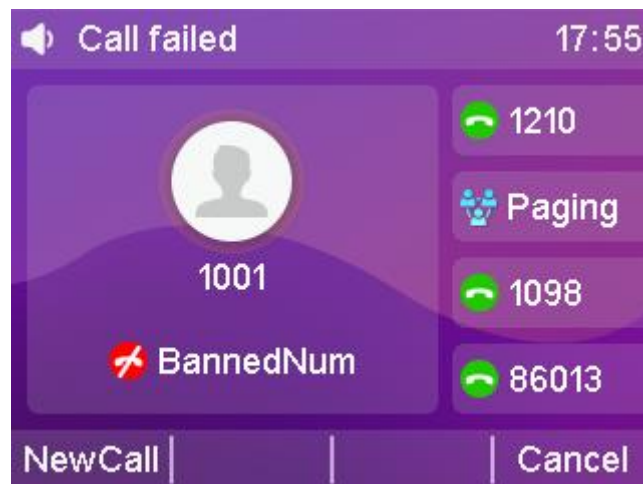

- Adding outbound restriction rules through the web interface

1. Log in to the phone page by IP address.
2. Click **Settings (E)** -> **Dialing Rules (k)** -> **Restrict Outgoing Calls**.
3. Fill in the Blocked Numbers field with the number you want to restrict calls to.
4. Account fill in the registered account of the restricted call.
5. Click the **Add** button to save the rule.

The screenshot shows the 'Dial Plan' configuration page in the IP Phone web interface. The 'Block Out' tab is selected. A table displays 10 rules. Rule 1 is highlighted in yellow. Below the table, a form for editing rule 1 is shown. The 'BlockOut Number' field contains '800' and the 'Account' dropdown is set to 'all'. The 'Add' button is highlighted with a red box and a red circle.

- Modify outbound restriction rules through the web interface

1. Log in to the phone page by IP address.
2. Click **Settings (E)** -> **Dialing Rules (k)** -> **Restrict Outgoing Calls**.
3. Tap the rule you want to modify in the restrictions outgoing rules List
4. Modify the rule in the rule input area, e.g.: (original: xxxxx --> change: 1xxxx).
5. Account area fill in the matching rules of the account (eg: the current registration account 8001), the default value is all (that all accounts).
6. Click the **Edit** button to save the modified rule.

The screenshot shows the 'Dial Plan' configuration page in the IP Phone web interface. The 'Block Out' tab is selected. A table displays 10 rules. Rule 1 is highlighted in yellow. Below the table, a form for editing rule 1 is shown. The 'BlockOut Number' field contains '800' and the 'Account' dropdown is set to 'all'. The 'Edit' button is highlighted with a red box and a red circle.

- Remove outbound restriction rules through the web interface

1. Log in to the phone page by IP address.
2. Click **Settings (E)** -> **Dialing Rules (k)** -> **Restrict Outgoing Calls**.
3. Tap the rule you want to modify in the restrictions outgoing rules List.
4. Click the **Delete** button to delete the rule.

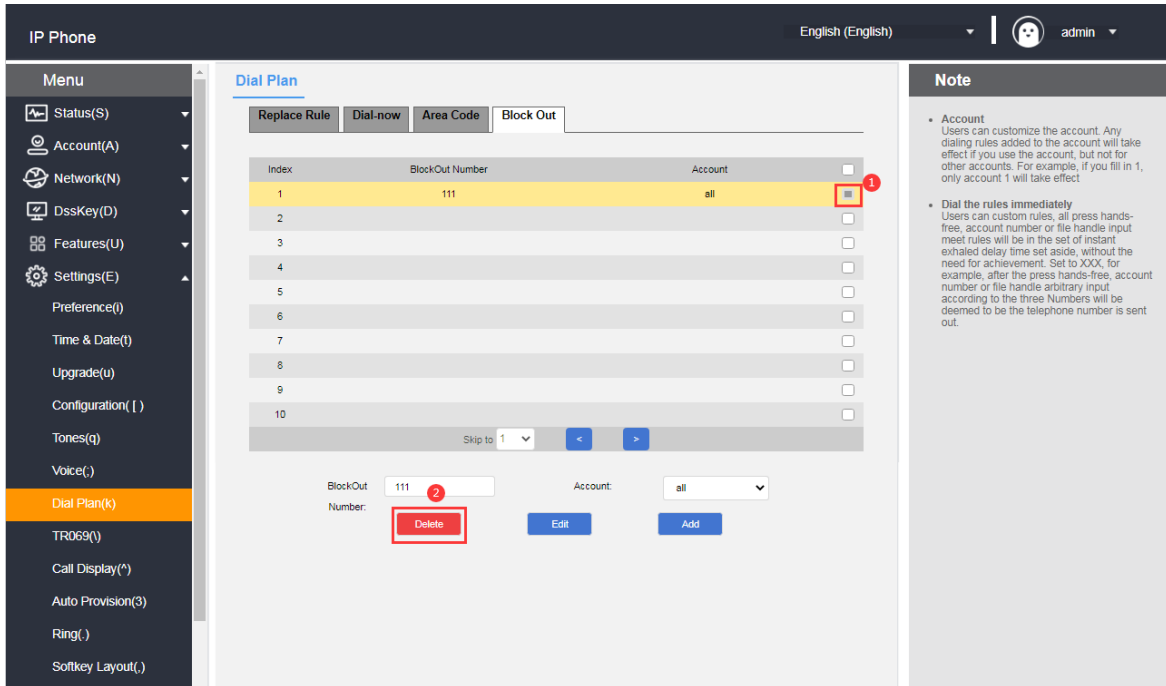

The screenshot shows the 'IP Phone' web interface. The top navigation bar includes 'English (English)' and a user profile 'admin'. A left sidebar menu lists various settings, with 'Dial Plan(k)' highlighted. The main content area is titled 'Dial Plan' and has four tabs: 'Replace Rule', 'Dial-now', 'Area Code', and 'Block Out'. The 'Block Out' tab is active, showing a table with columns 'Index', 'BlockOut Number', and 'Account'. The first row (Index 1) is highlighted in yellow and has a red '1' in a circle pointing to a 'Delete' button. Below the table, there are input fields for 'BlockOut' (value: 111) and 'Account' (value: all), and a 'Delete' button.

Index	BlockOut Number	Account	
1	111	all	Delete
2			
3			
4			
5			
6			
7			
8			
9			
10			

BlockOut: 111 Account: all

Number: [Delete] [Edit] [Add]

Basic Functions

This chapter introduces the basic functions of the telephone as follows:

- [make a telephone call](#)
- [answer the phone](#)
- [end a call](#)
- [redial](#)
- [distraction-free](#)
- [call transfer](#)
- [call transfer](#)
- [Call Waiting](#)
- [PIN call](#)

- [call hold](#)
- [Auto Replay](#)
- [Call completion.](#)
- [auto-answer](#)
- [anonymous call](#)
- [hotline](#)
- [two-dimensional barcode](#)
- [sessions](#)
- [Upgrade](#)
- [Upload ringtones](#)
- [Capture & Diagnose](#)
- [reset](#)
- [configuration management](#)

make a telephone call

You can choose the way to make a call ① manual dialing, ② call list, local contact selection number dialing.





For the way to dial a phone record and local contacts, please see [Contact Management](#) and [CDR Management](#) for more information.

The phone can be called using three tools:

- Handset
- headset
- hands-free (of telephone etc)

- Using the handset to make calls

Any of the following may be used:







Mode 1	Mode 2
1. Pick up the handset when the phone is idle	1. Enter the number in the idle state of the phone.
2. Enter the number	2. Pick up the handle
3. Press  ,  or the Dial soft	Press  ,  or the Dial soft key to

key to call out the number.	call out the number
-----------------------------	---------------------

Description The default call out key of the phone is #, you can also set it to * or not set this key as call out key, please check the detailed setting method. [Outgoing Keys](#) section.







- Talking with a headset

Any of the following may be used:

Mode 1	Mode 2
1. After connecting the headset, press  to enter headset mode	1. After connecting the headset, press  to enter headset mode
2. Enter the number	2. Press the account number button to enter the dialing interface, enter the number
3. Press  ,  or the Dial soft key to call out the number.	3. Press  ,  or the Dial soft key to call out the number

- Talking on the speakerphone

Any of the following may be used:









Mode 1	Mode 2
1. Press the hands-free key  to enter the dialing interface	1. Enter the number in the idle state of the phone.
2. Enter the number	2. Press  ,  ,  or the Dial soft key to call out the number.
3. Press  ,  or the Dial soft key to call out the number.	

Description The three call tools can be selected by dialing the number first.
You can dial the number by calling the IP address on the

- multi-way calling

The phone supports multiple calls, up to 2 calls per account, while one call is in progress, the other way of call is on hold.

A new call can be initiated using any of the following methods:

Mode 1	Mode 2
1. During a call, press the account number key, the current call will be put on hold and enter the dialing interface	1. During a call, press the Hold soft key to put the current call on hold.
2. Enter the number	2. Press the New Call soft key to enter the dialing interface, enter the number
3. Press  ,  or the Dial soft key to call out the number	3. Press  ,  or the Dial soft key to call out the number
4. Press  or  to toggle the number and press the Resume soft key to resume the call.	4. Press  or  to toggle the number and press the Resume soft key to resume the call.

- Allow IP calls

The phone supports configuration of whether to allow IP calls.

1. Click **Functions (U)** → **Basic Information (5)** from the homepage.

Enable: the phone allows direct IP dialing;

Disable: when calling IP, it prompts: account is unavailable; when called, you cannot receive direct dialing from IP, and you will receive missed calls from IP after restoration.

2. Click **Submit** to save the configuration.

- IP Direct Dial Auto Attendant

The phone supports the configuration of whether or not to activate IP direct dialing auto-answer.

1. Click **Functions (U)** → **Basic Information (5)** from the homepage.

Enable: Automatically connects incoming IP calls;

Disable: need to manually connect an incoming IP call.

2. Click **Submit** to save the configuration.

Answer the phone

The phone can answer calls using three tools:

- Handle
- headset
- hands-free (of telephone etc)

- Answering an incoming call using the joystick

When phones is ringing pick up the handle.

- Answer a call using the speakerphone

When the phone is calling, press the **Answer** soft key or the speakerphone key



- Answering an incoming call using a headset

When the phone calls

1. Headset mode is activated, press the **Answer** soft key or press the account key that is blinking to answer.

2. Headset mode is not activated or is activated already, press  Headset to answer.

- Reject the call.

Press the **Reject** soft key for incoming call rejection.

If you set up Do Not Disturb, you can automatically reject calls, for details see [Do Not Disturb](#) section.

End a call

If you want to hang up during a call, you can use the following methods:

1. To talk using the handle: press the **Hang Up** soft key or return the handle to the phone.

2. To use a hands-free call: press the **Hang Up** soft key or the hands-free key



3. To talk using the headset: press the **Hang Up** soft key.

Redial









The phone can quickly redial the last call or any call by using the  button on the phone. You can use different ways to redial as follows:

- Redialing with the handset

1. Pick up the handle.
2. Press  to dial the last call.

- Use of hands-free redialing

Hands-free redial can be used in any of the following ways:

Mode 1	Mode 2
<p>1. Redial the last call</p> <p>Press the  button twice to redial the last call</p>	<p>1. Press  to enter hands-free dialing</p>
<p>2. Redial any call</p> <p>1) Press the  button once</p> <p>2) Press  or  to switch the number</p> <p>3) Press , the Call soft key or  to redial any call.</p>	<p>2. Press  to redial the last call.</p>





- Redialing using a headset

You need to activate the headset mode first, the specific activation method to see [Using the headset](#) section for details on how to activate the headset.

1. Redial the last call

Press the  button twice to redial the last call.

2. Redial any call

- 1) Press the  button once.
- 2) Press  or  to switch the number.
- 3) Press , the Call soft key or  again to redial any call.

DND

You can set the phone for Do Not Disturb mode, after setting the Do Not Disturb mode, the phone will display  icon on the upper right corner of the phone, the phone will not ring when receiving an incoming call and inform the other party that it is busy, and display a missed call alert on the local phone, as shown below:

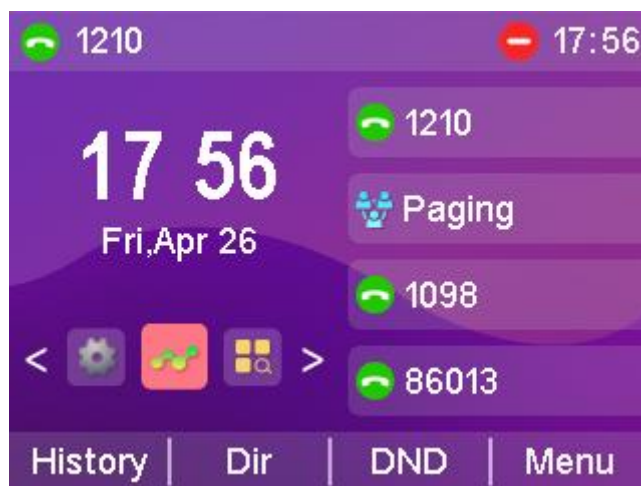

Disturbance Free has two modes to choose from:

- **Phone Do Not Disturb (Factory Default Mode):** Turning on this mode will turn on Do Not Disturb for all accounts.
- **Customized Do Not Disturb:** You can select a specified account to set do not disturb.

- Setting up do-not-disturb on web pages

1. Log in to the web interface.

2. Click **Features (U) -> Call Forwarding & Do Not Disturb (4)**.
3. In the Do Not Disturb Settings area, select Do Not Disturb Mode: Phone or **Custom Mode**.
4. If you select Custom Mode, select the extension you want to turn on Do Not Disturb.
5. The Do Not Disturb status is set to **On**.
6. Click Submit to save.

Description The Do Not Disturb mode switch can only be set in the web interface.

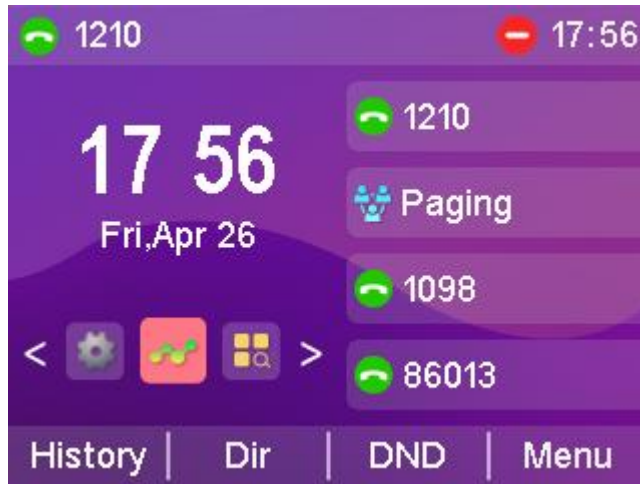

- In phone mode, turn on Do Not Disturb in the phone screen.
1. Press the **Do Not Disturb** soft key while the phone is in standby to set it.
 2. or press **Menu->Functions->Do Not Disturb**.
 3. Press the **Toggle** soft key to toggle.
 4. Finally, press the **Save** softkey to save the operation.

When Do Not Disturb is turned on, the  icon is displayed in the upper right corner of the phone.



- Enable Do Not Disturb in the phone interface in customized mode

1. When the phone is in standby, press the **Do Not Disturb** soft key or press **Menu->Features->Do Not Disturb** to enter the customized Do Not Disturb setting interface.

2. Press  or  to select the account for which you want to set up Do Not Disturb.

3. Press the **Toggle** soft key or the **Left and Right** buttons to select Enable.

4. Press the **Save** soft key or the  key to save the operation.

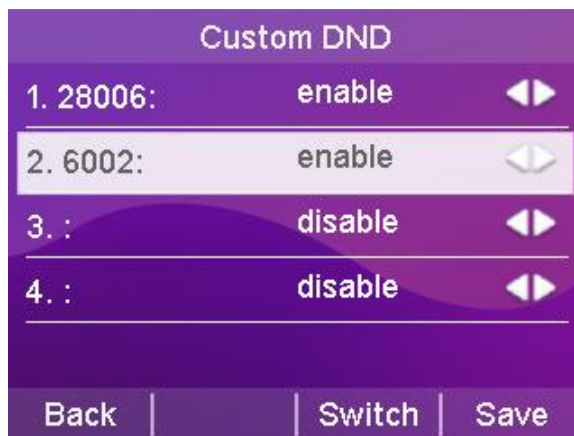

Call transfer

After setting the call transfer on, the external call to the IP phone will be automatically transferred to the set up of other phones or cell phones, call transfer is divided into two types, when the phone has an incoming call ringing press the **transfer** soft key to dial the number to transfer (active transfer), when the phone

has an incoming call automatically transferred to a pre-set number (automatic transfer).

Voluntary transfer

- Transfer operation process

1. When there is an external incoming call, the handset is in the ringing state.
2. Press the **FWD** soft key.



3. Enter the number to be transferred.
4. Press the  **button/Send** soft key to transfer the call.

Automatic transfer

There are several main types of automatic transfers:

- Unconditional transfer: all incoming calls to the phone are transferred to the preset number .
- Busy Transfer : When the phone is busy, calls are transferred to a preset number.
- No-Answer Transfer: When no one answers during the ringing period of an incoming call, the call is transferred to a preset number after a timeout.

-Set the call forwarding authentication number through the web page interface:

1. Click on Features (U) -> Call Forwarding & Do Not Disturb (4);
2. Enable Call Forwarding Emergency Number under Call Forwarding Area;

3. Enter the corresponding numbers in the Call Forwarding Authentication Number field, with multiple numbers separated by ",";

4. Click Submit to save the operation.

After the authentication number is turned on, the number comes to the telephone set without transfer processing, and the authentication number is common to the account;

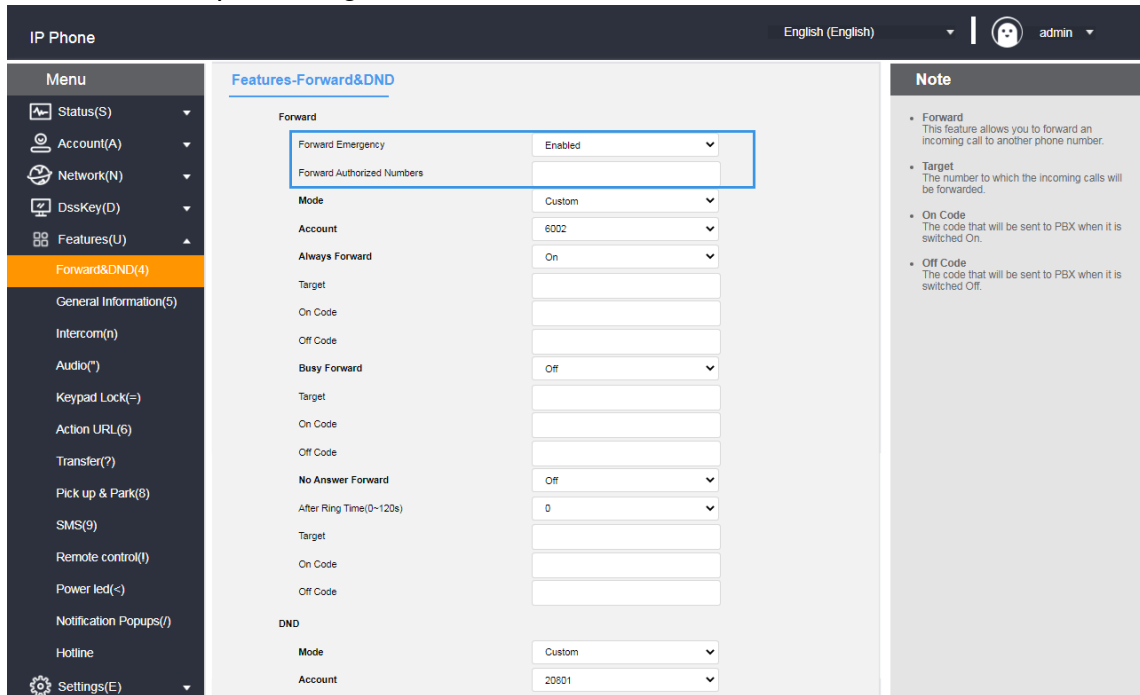

- Setting up call forwarding through the web interface

1. Press **Function (U) -> Call Forwarding & Do Not Disturb (4)**.

2. Under the Call Forwarding Mode area, select the mode: Custom: Custom mode enables call forwarding for a specific account or all accounts; Phone Mode: Call forwarding will be applied to all accounts on the handset.

3. Select the transfer method to be set as desired and select On.

4. Fill in the **target number** to be transferred.

5. Setting the feature code on and off in the call forwarding area (optional)

6. Click the **Submit** button at the bottom of the page to save

Note: If you configure a call forwarding feature code, the phone will send the corresponding feature code to the server. For example, if you set the feature code of unconditional transfer on to *72, and the feature code of unconditional transfer off to *73, and the transfer number is 1000, when you turn on the unconditional transfer, the phone sends *721000 to the server, and when you turn it off, it sends *731000 to the server, so that the server can synchronize the unconditional transfer function to be turned on/off.

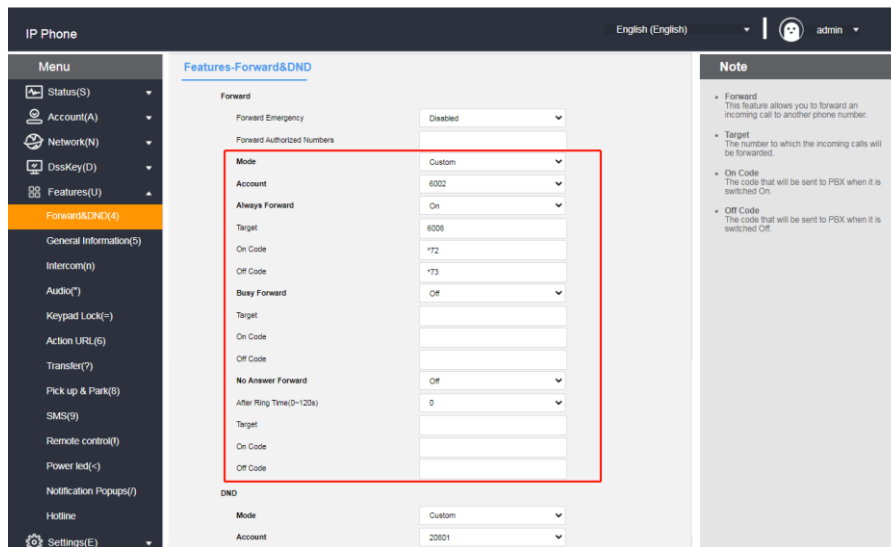

- Setting up call forwarding through the handset interface



1. Press **Menu->Functions->Call Forwarding**.

2. Select the transfer method to be set as desired:

✧ unconditional transfer

1) Press  or  to select Enter Unconditional Transfer.

2) At the Status option, press the **Toggle** soft key to turn on/off.



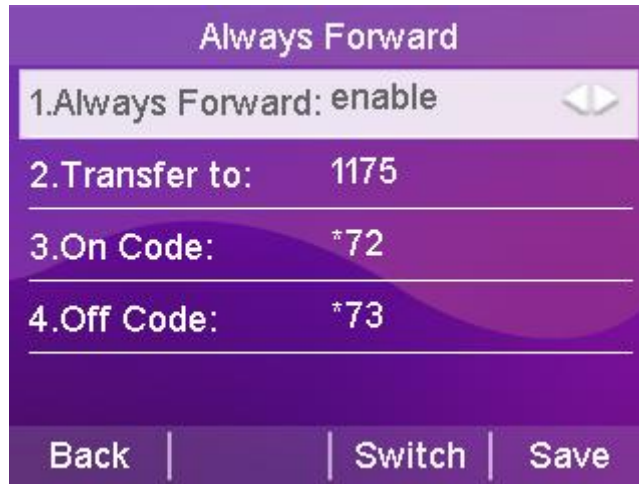

3) Press  or  to select the number item and fill in the number in case of unconditional transfer.

4) (Optional) Enter the unconditionally transferred on feature code and off feature code in the on feature code and off feature code areas respectively.

5) Press the **Save** soft key to save the operation.







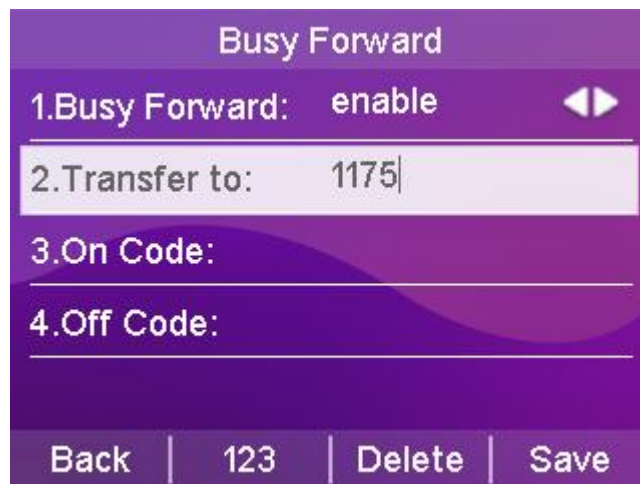

✧ Call forwarding when busy

- 1) Press  or  to select Enter Busy Transfer.
- 2) At the Status option, press the **Toggle** soft key to turn on/off.
- 3) Press  or  to select the number item and fill in the number in case of busy transfer.
- 4) (Optional) Enter the on feature code and off feature code for busy transfer in the on feature code and off feature code areas respectively.
- 5) Press the **Save** soft key to save the operation.



✧ Non-responsive transfer

- 1) Press  or  to select entering No Answer Transfer.
- 2) At the Status option, press the **Toggle** soft key to turn on/off.
- 3) Press  or  to select the number item and fill in the number to be transferred.
- 4) Press  or  to select no answer time, fill in the waiting time

before you want to transfer, default 5 Seconds.

5) (Optional) Enter the no-answer transfer on feature code and off feature code in the on feature code and off feature code areas respectively.

6) Press the **Save** soft key to save the operation.

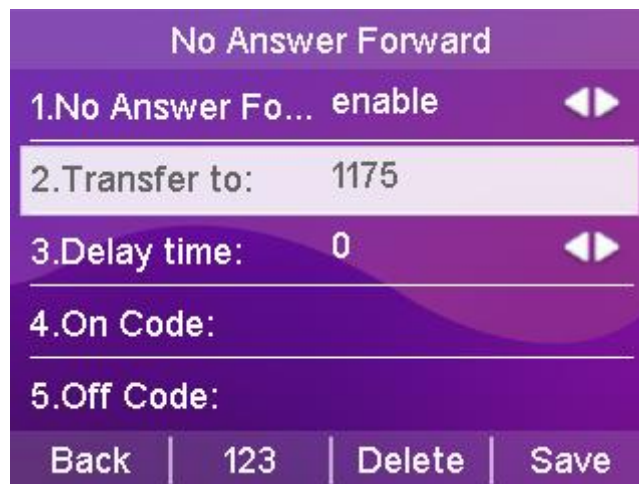

When Call Forwarding is turned on, the LCD screen displays the Call Forwarding Enabled icon when the phone is in standby.

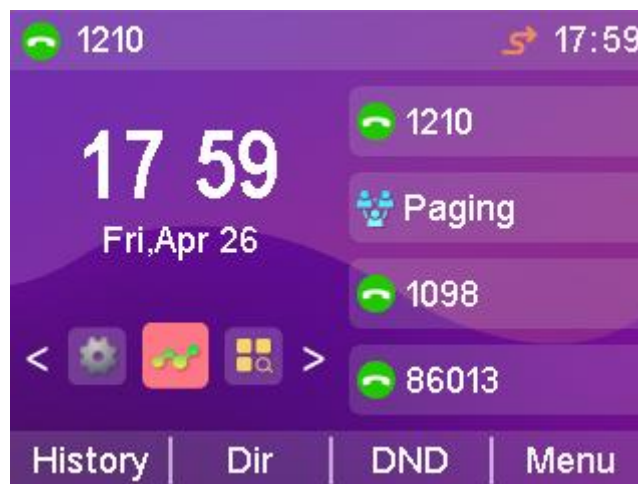

Description If the call forwarding feature has been set up in advance, call forwarding can be quickly turned on/off by using the TRANSFER button on the phone panel.

call forwarding

Call Forwarding is categorized into the following two types:

- **Blind transfer:** Direct transfer to the other party without consultation with the transferring party.
- **Consultation transfer:** When consultation with the person to whom the call is to be transferred is completed and the transfer is agreed upon, the call is transferred to the other party.

Blind transfer

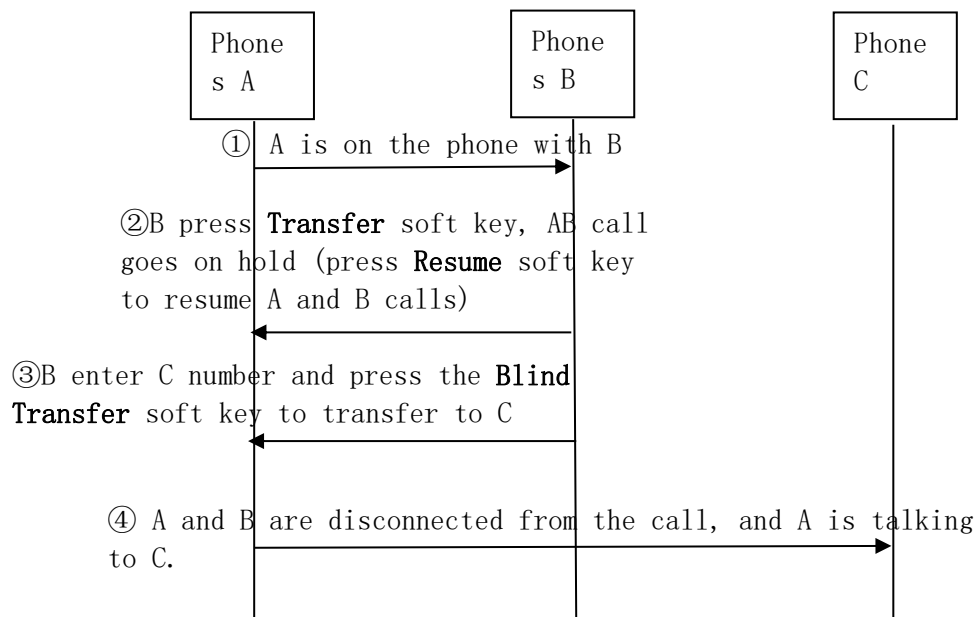

Blind transfer flowchart

- Blind transfer operation process:

1. Handset A is talking to handset B.
2. Handset B presses the **Transfer** soft key or the Transfer button.
3. The called number input for blind transfer can be done in the following two ways:

a) Enter the number directly

1) B enter the number of the transferred phone C. After entering the number, the **blind transfer** soft key appears on the LCD display of the phone B.



2) Phones B press the **BTra** soft key.

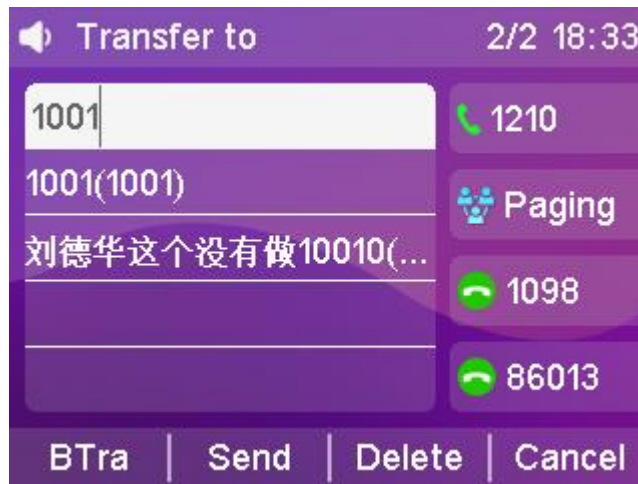

3) The call between B and A will be interrupted and the incoming call is forwarded to Phone C.





b) Selecting numbers by contact

1) B Press the **Dir** soft key.

2) Press  or  to select a group and press the **Enter** soft key to enter the group.

3) Press  or  to select the contact to be transferred and press the **Send** soft key.

4) Press  or  to select the phone or cell phone you want to transfer to and press the **Transfer** soft key to blind transfer.

5) The call between B and A will be interrupted and the incoming call is forwarded to Phone C.

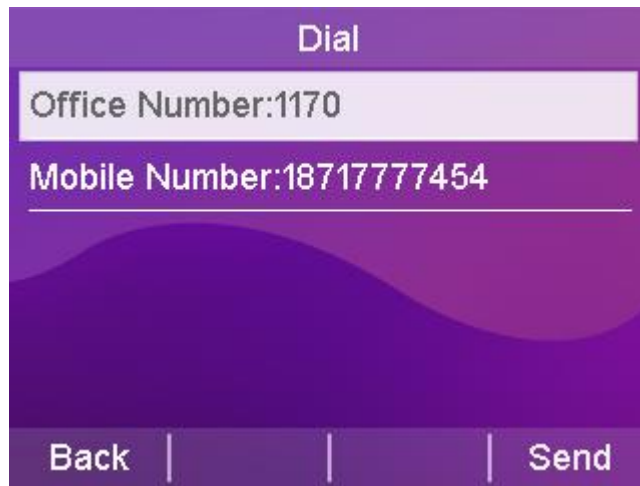

- Eliminate the blind turn operation process:

When Phones A and B are talking, after Phones B presses the **Transfer** soft key, Phones B and A will enter a call hold state, and the calling party will hear the ringing of the call hold, and if they want to exit the transfer operation, press the **Resume** soft key, and the call between Phones B and A will be resumed.

Advisory Transfers

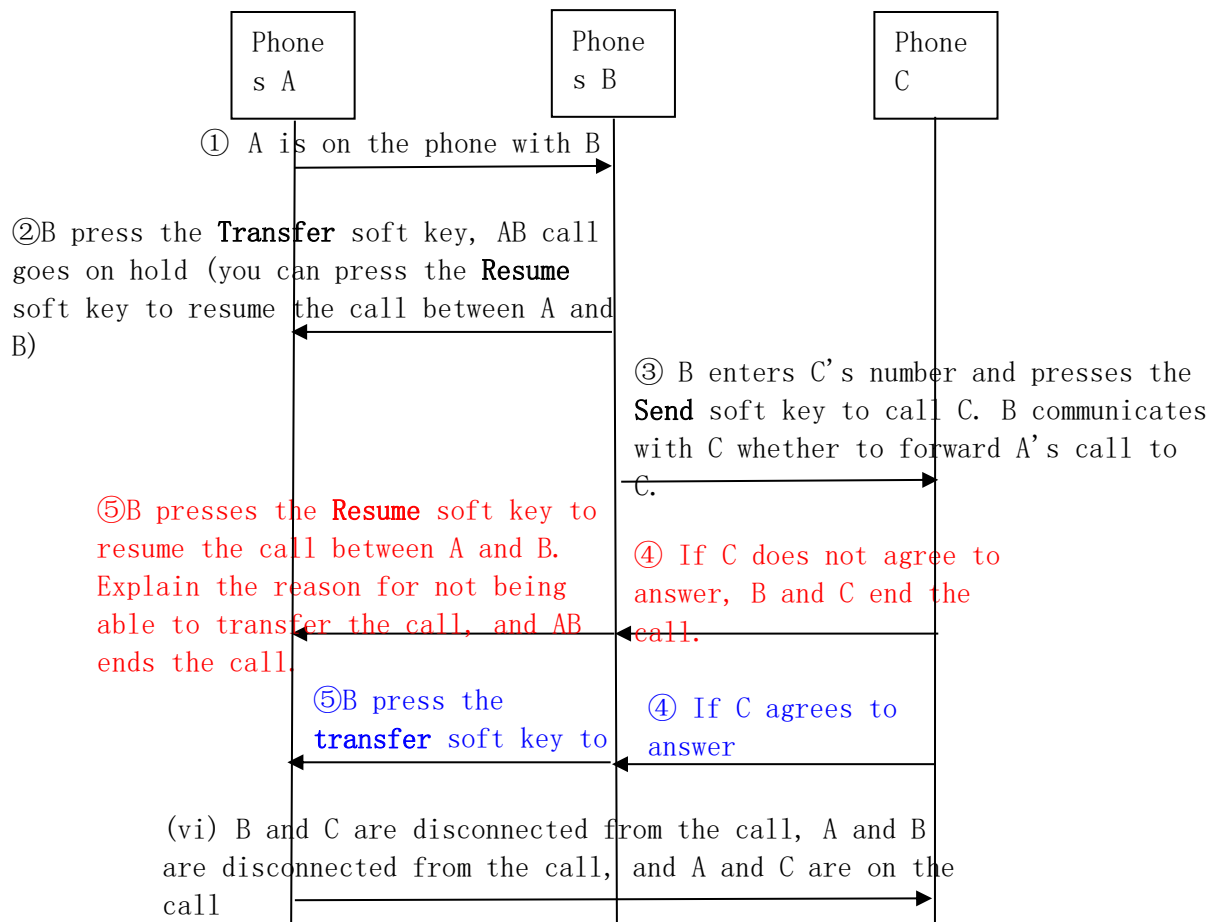

Consultation Transfer Flowchart

- **Consultation transfer operation process:**

1. Handset A is talking to handset B.
2. Handset B presses the **Transfer** soft key or the Transfer button.
3. Enter the number of the transferred phone C. The LCD display shows the **Send** soft key.
4. After pressing the **SEND** soft key, phone B will talk to phone C. Phone B asks phone C if he wants to accept an incoming call from Handset A.
5. It is divided into the following two cases:
 - a) Phone C is unable to answer the call
 - 1) Phone C refuses to answer a call from A or Phone C is unavailable.
 - 2) Phones B and C end the call.
 - 3) Phone B presses the **Resume** softkey to resume the call with Phone A and informs Phone A that it is unable to answer.
 - 4) End of transfer.
 - b) Phone C can answer the call
 - 1) Phones B and C have finished negotiating, and Phone C can answer incoming calls from Phone A.
 - 2) Phone B presses the **transfer** soft key.
 - 3) The call between B and A will be interrupted and the call will be forwarded to C and A will talk to C.

Call Waiting

If you enable Call Waiting feature, you can receive new incoming calls during the call, otherwise new incoming calls will be automatically rejected during the call, if you enable the Play Tone feature, when you receive a new incoming call during the call, the handset will ring a "beep" tone, otherwise new incoming calls will not be reminded of this.

-Set up call waiting through the web interface

1. Click Menu → Functions (U) → Basic Information (5).

2. Enable call waiting, set on/off feature code (different feature code for different PBX).

3. Press Submit to save the operation or Cancel to cancel it;

If Enable/Disable Feature Code is set, when Enable/Disable Call Waiting the phone will use the default account to send the feature code to the server (only this account is enabled not all accounts) to synchronize Enable/Disable Call Waiting;

If the phone does not have a feature code set:

When the server turns on call waiting, the phone turns on and off call waiting normally;

It is not valid for the phone to turn on call waiting when the server does not turn on call waiting;

Features-General Information	
Call Waiting	Enabled
Call Waiting On Code	
Call Waiting Off Code	
Auto Redial	Enabled
Auto Redial Interval (1~300s)	3
Auto Redial Times (1~300)	3
Accept SIP Trust Server Only	Disabled

-Set the call waiting function on the phone

1. Click Menu → Function → Call Waiting;

2. Enable or disable the call waiting function (common account).

3. Enable or disable the beep tone. Whether a beep tone is played for a new call during a call.

4. Enable the feature code (optional) to be sent to the server during call waiting.

5. Disable the feature code that is sent to the server during call waiting (optional).

Call Waiting

1.Call Waiting: enable

2.Play Tone: enable

3.On Code: *11

4.Off Code:

Back | 123 | Delete | Save

PIN call

If you are making a call and do not want the caller to see the number you are dialing you can enable passcode calling.

- Setting up password calls via the web

1. Click Menu → Functions (U) → Basic Information (5).
2. Setting up a password call; and

PswPrefix	10
PswLength	5
PswDial	Enabled

3. Press Submit to save the operation or Cancel to cancel it;

The last 5 digits of a number starting with 10 will be replaced by * after successful configuration;

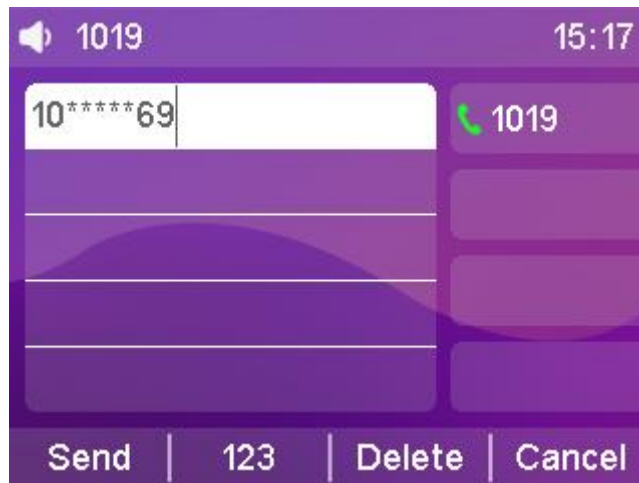

call hold

When you have an emergency to deal with while you are on a call, you can press the Hold button to enter the call hold state, and the server will play a hold tone for the other end.

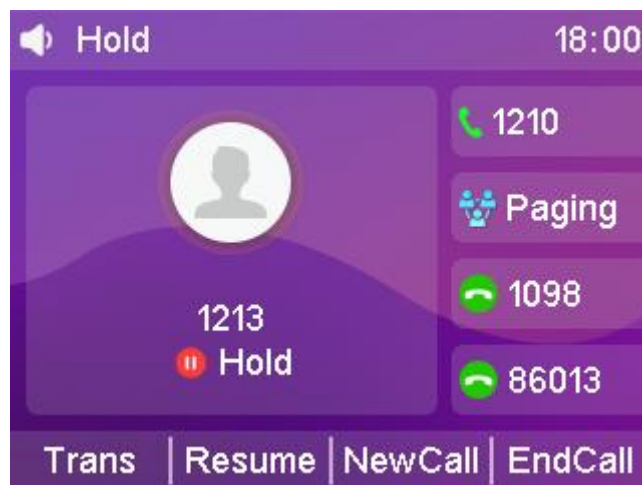

- Setting the Hold Tone via the Web

1. Click Menu → Functions (U) → Basic Information (5).
2. Setting the hold tone.
 - a) Call Hold tone;
 - b) Call Hold tone delay;
 - c) Hold cue interval;
 - d) Call Held Tone;
 - e) Call Held tone delay;
 - f) Held beep interval;

3. Press Submit to save the operation or Cancel to cancel it;

When you enter Hold Mode after turning on the beeper, the beeper will play "Di";

- Setting RFC 2543 Hold Mode via the Web

1. Click Menu → Account (U) → Advanced (5);
2. Set to enable/disable RFC 2543 hold mode;
3. Press Submit to save the operation or Cancel to cancel it;

The PBX does not play hold tones when RFC 2543 hold mode is enabled;

Automatic redial

If you enable auto redial, the phone will show auto redial prompt in LCD interface after call failure, you can also set auto redial interval and auto redial times.

-Set up automatic redialing through the phone interface:

1. Press **Menu** → **Features** → **Auto Redial**;
2. Select Enable Auto Replay, set Auto Replay Interval (in seconds, default 10, range 1-300), and set Replay Count (default 10 range 1-300);
3. Press Save to save the operation or Return to cancel the operation.

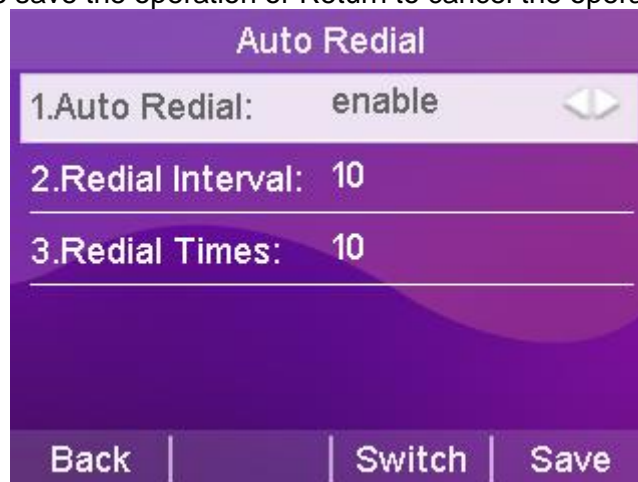

-Set up automatic redialing through the web interface:

1. Press Function (U) → Basic Information;
2. Select Enable Auto Redial, set the Auto Redial Interval (in seconds, default 10, range 1-300), and set the Replay Count (default 10 range 1-300);
3. Click the **Submit** button at the bottom of the page to save

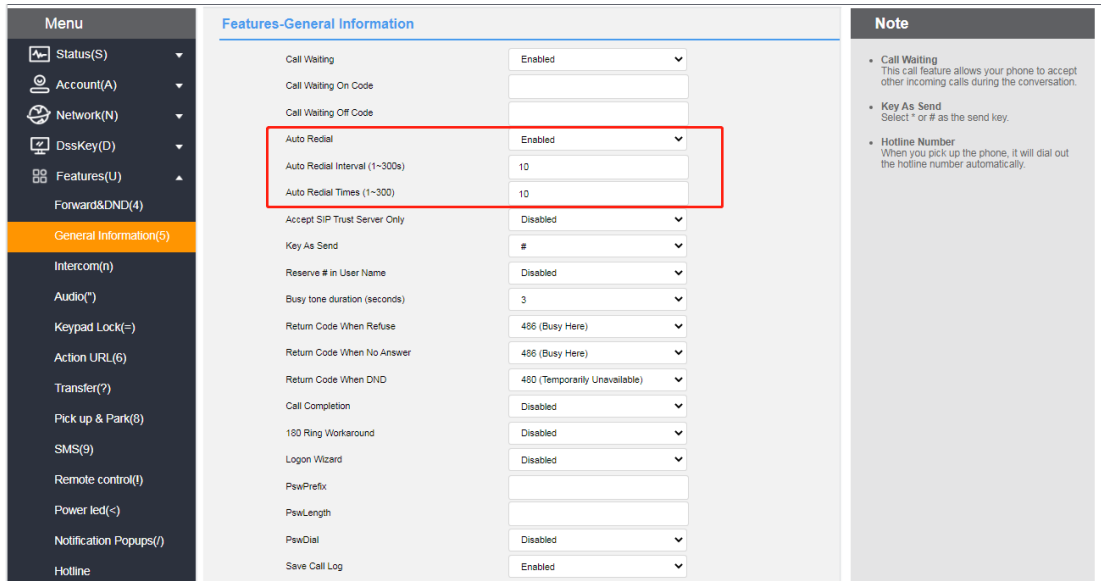

Using the automatic redial function

When the phone call fails, the phone LCD interface prompts as follows:

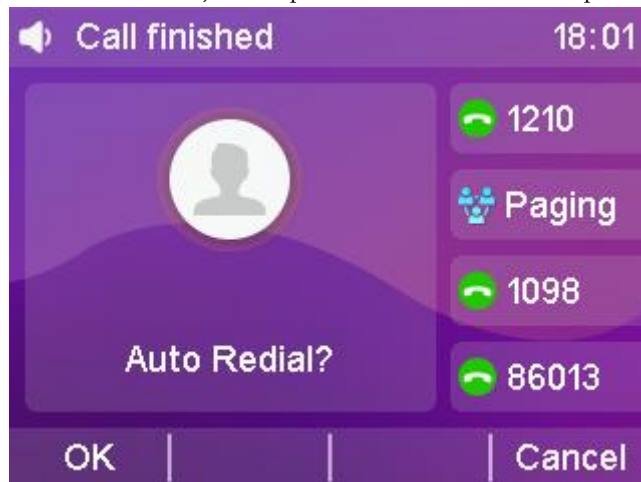

1. Press the **OK** soft key to activate the Auto Redial feature. The phone LCD interface prompts as follows:

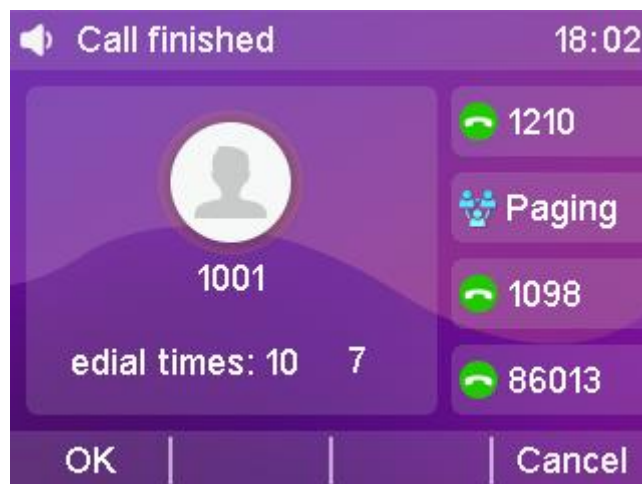

2. Press the OK soft key or wait for a period of time (redial interval), the phone will call out the number again.

The phone will dial the called user for the set number of redials.

status return code

The phone can set the status return code for Reject/No Answer/Do Not Disturb.

- Setting the status return code through the page

1. Log in to the Web interface.
2. Click **Function (U) -> Basic Information (5)**.
3. Set the status return code supporting: 404/480/486/600/603.
4. Click the **Submit** button at the bottom of the page to save the configuration.

After successful configuration the phone sends the corresponding return code to the peer:

Call completion.

When the phone is enabled for call completion, the phone calls the user who is in the busy state and enters the Call Waiting Alert screen, and the server will notify the phone to redial when the called user turns to the idle state;

- Call completion through page setup

1. By **function (u) -> Basic information (5)**
2. Select **OK**

When the called user is busy, the phone interface prompts as follows:

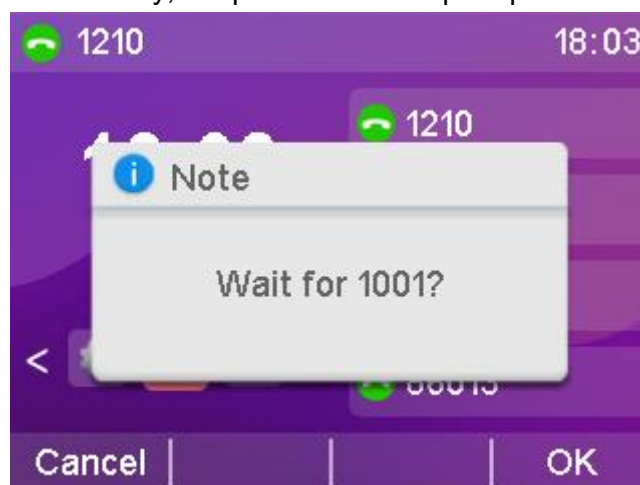

After pressing Confirm, when the called user turns to idle status, the phone interface will show the following prompt:

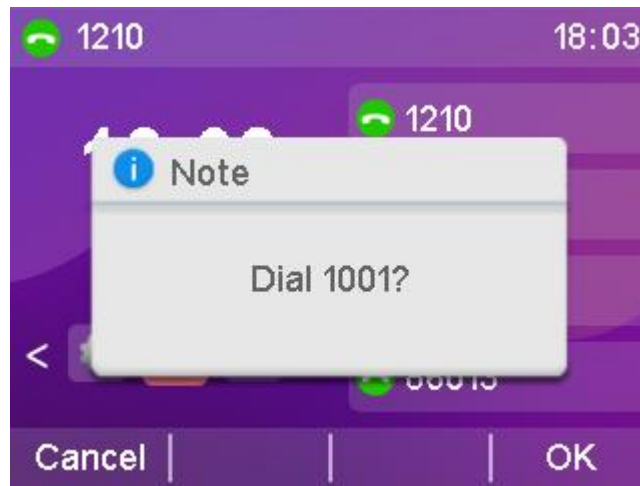

Busy state has been tested to detect only the call state, other states are not detected, all others will prompt the calling user to switch to idle state.

Other can only enter the busy state when it is not possible to dial, it is not possible to detect whether it is idle or not, e.g., DND, blacklist, etc. are not detected;

If the user's transferred number dialed by the phone is busy, the phone will enter the call completion interface but cannot detect the transferred number status, and after detecting the normal state of the dialed phone, it will be prompted to dial the number. For example, if the call completion is enabled on phone A (call completion), phone B (called number, unconditional transfer to phone C is enabled), and phone C (transferred number, DND is enabled), phone A dials phone B, and phone A enters the call completion interface, and after a period of time, it will jump to the dialing interface, and it will not be affected by whether or not DND is turned off on phone C.

Attention:

Call completion requires server support.

Call Completion If there are multiple calls only the dialed call hangs up and prompts for dialing;

Multiple call waiting screens will not appear, and the call waiting screen disappears after operating the call;



Exit Call Waiting prompt does not disappear before entering the dialing screen without dialing, and incoming calls do not interrupt call completion.

Auto-answer

You can set up an auto-answer function for the registered account of the phone.

When an account with auto-answer enabled receives an incoming call, the phone will automatically answer the call after the set auto-answer wait time.

- Setting up Auto-Answer through the handset interface

1. Press **Menu->Functions->Auto Answer**.
2. Press  or  to select the account you want to enable auto-answer.
3. Press the **Toggle** soft key to toggle the enabled or disabled state.
4. Press the **Save** soft key to save the operation.

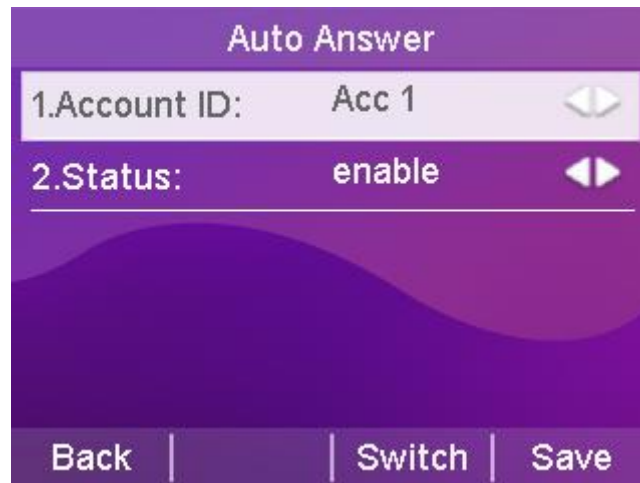

When Auto Answer is turned on, the Auto Answer icon  appears on the display of the handset standby, indicating that the handset is in the Auto Answer state.

When the phone is in a call state, it will not answer automatically.

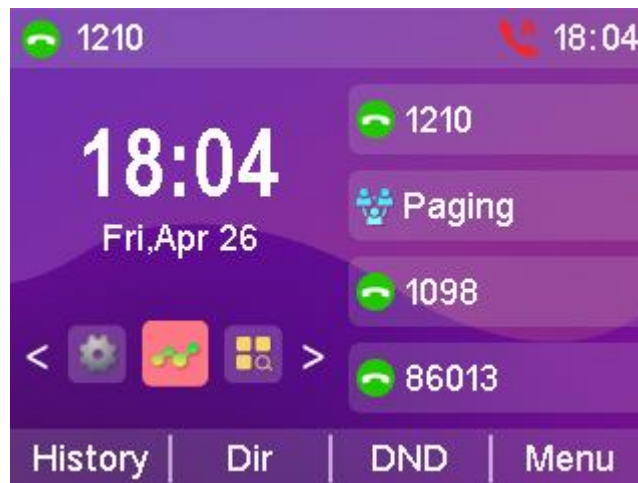

Anonymous call

The phone can turn on the anonymous reject feature to automatically reject an anonymous call when it comes in. If the server supports the anonymous reject function, you can also turn on/off the anonymous reject function of the account by dialing the server's service code.



At the same time, the phone can turn on the local anonymity function, the call initiated by this phone, the other party can not see the caller number, But after turning on the anonymity ,it may be rejected by the other party.

- Setting up an anonymous reject function through the phone interface

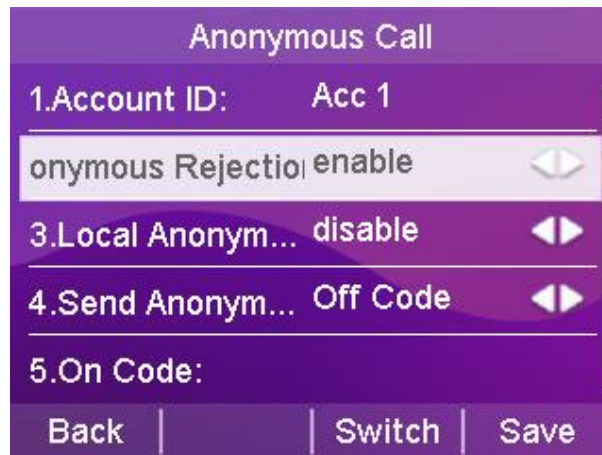
1. Press **Menu->Features->Anonymous Call**.
2. Press the **Toggle** soft key to toggle the Enable or Disable state of **Anonymous Reject**.
3. Press the **Save** soft key to save the operation.



- Setting up local anonymization through the handset interface

1. Press **Menu->Features->Anonymous Call**.
2. Press  or  to select the local anonymization option.
3. Press the **Toggle** soft key to toggle the **local anonymization** enabled or disabled state.
4. Press the **Save** soft key to save the operation.

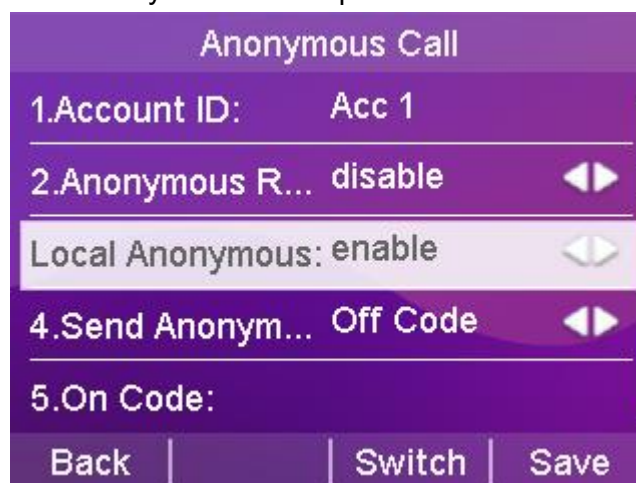

- Setting up anonymous reject/local anonymization through the web interface

1. Log in to the Web interface.
2. Click **Account->Advanced**, as shown below.
3. Select the account for which you want to enable anonymous rejections.

4. Select **Enable** in the Anonymous Reject field/Local Anonymous field.
5. If you select Enable in the feature code bar of the local anonymous/Anonymous reject switch, the corresponding feature code is sent (optional).
6. Enter the corresponding feature code (optional) in the Enable/Disable feature code field. The server provides different feature codes.
7. Click **Submit** to save.



In this example, the anonymous call enabled feature code *11 is sent to the server, and the server synchronously enables the anonymous call. Note: The anonymous call function must be supported by the server; otherwise, it has no effect after being enabled.

Identity	Account1
DTMF:	INBAND
DTMF Info Type	DTMF-Relay
DTMF Payload Type (96~127)	101
Local anonymous	Enabled
Anonymous Reject	Enabled
Anonymous Code	On Code
On Code	*11
Off Code	*12
Anonymous Reject	Off Code
On Code	
Off Code	
User Agent	T780N
RTP Encryption(SRTP)	Disable

Hotline

You can set a frequently dialed number as the hotline. When using the hotline, when you pick up the handset, press the speakerphone, or use the headset for dialing, wait for the hotline delay time to expire, and the phone will automatically dial the set hotline number. If the delay time is set to 0, the hotline number will be called out immediately upon dialing.

- Setting up hotline functions through the telephone interface

1. Press **Menu->Functions->Hotline**.
2. Fill in the hotline number to call.
3. Press  or  to select Hotline Delay Time and fill in the number of seconds after the handset is taken off the hook to automatically dial the hotline.
4. Press the **Save** soft key to save the operation.

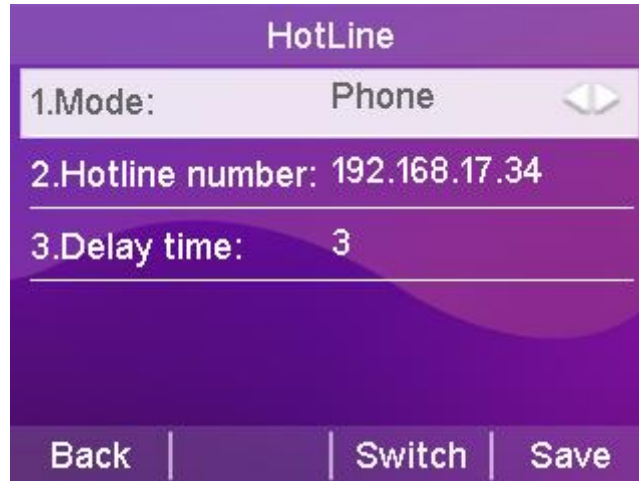

---Set the hotline function on the web UI

1. Log in to the Web UI.
2. Click Function (U) -> Hotline, as shown below.
3. If the configuration is general, the entire device is common.
4. Custom can be set according to the account situation.
5. Account: Select the account for which you want to open the hotline.
6. Hotline number: Enter the outgoing number.
7. Hotline delay (0-10S) : Wait for the hotline to be executed after entering into the dial interface(picking up handset or pressing the account key etc.)
8. Click Submit to save.

Features-Hotline

General

Hotline Number

Hotline Delay(0 ~ 10s)

Customize

Account

Hotline Number

Hotline Delay(0 ~ 10s)

Two-dimensional barcode

The IP Phone supports scanning the QR code provided by the phone to access the web interface through a smart phone, so as to configure the information of the phone on the phone. Before scanning the QR code, the cell phone must be connected to the same network segment as the phone, such as connecting to the router's WIFI.

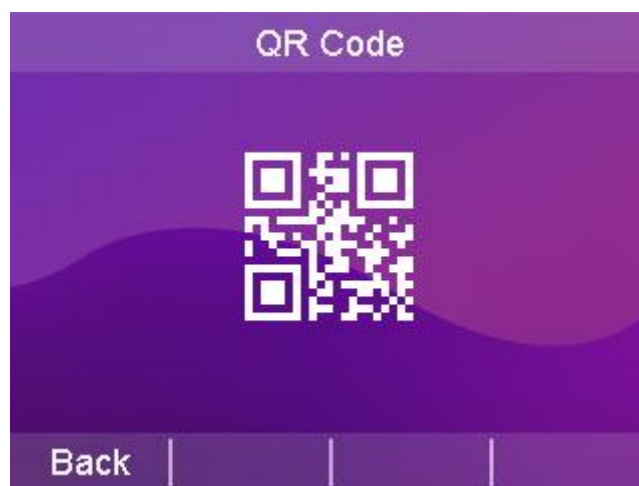

The interface of the cell phone logging in the phone belongs to the following figure, the specific use method is the same as the computer web operation, to understand the configuration method of each function, please go to the function introduction of each chapter to view, if there is any question about the use of QR code, please contact your network administrator.

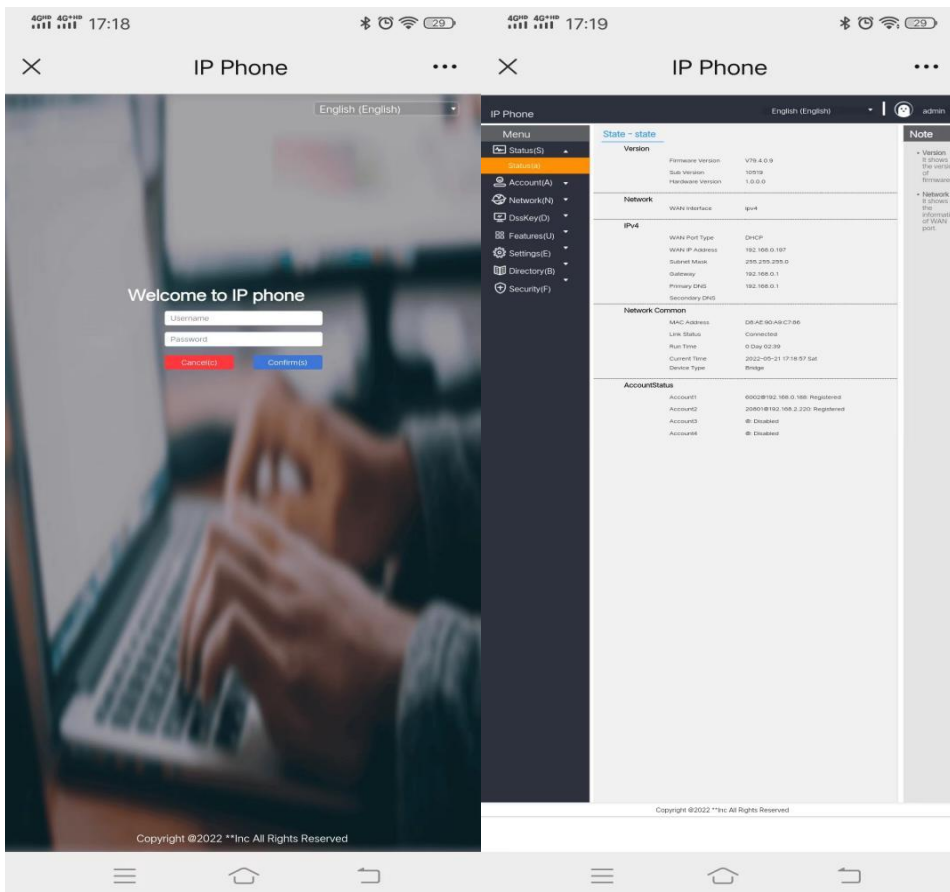

Conference

The phone can initiate a three-way call locally and use the **Conference** softkey during a two-way call to invite a third party call into the current call.

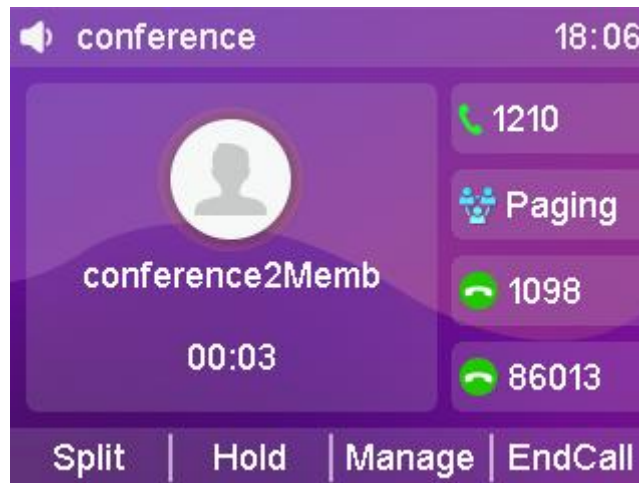

- Create a local three-way call at the phone

1. It happens in the middle of a call between A and B.
2. A presses the **Conference** soft key to initiate a three-way call, the call between A and B goes on hold, and A enters the dialing interface.
3. A Enter the C number and press the **Dial** soft key.
4. When C answers the incoming call, A presses the **Conference** soft key and ABC will start a three-way call.





- Add calls from both accounts to a three-way call

1. **Account 1** of Handset A is talking to Handset B, and **Account 2** of Handset A is talking to Handset C (but is on hold).

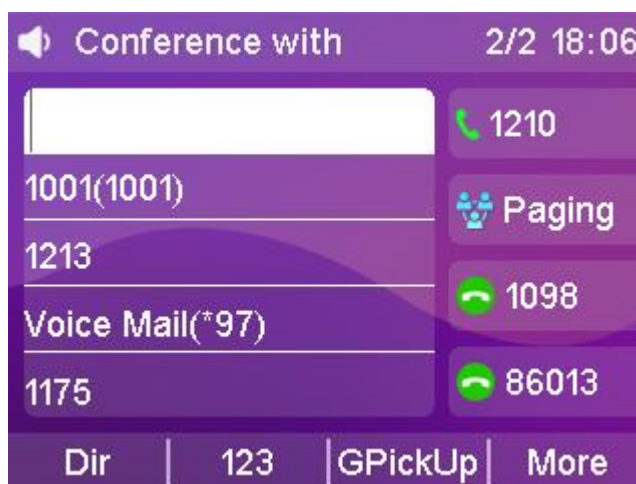
2. If Account 1 is on a call and Account 2 is on hold, press  or  to switch the call, using the account 1 that is on a call, press the **Conference** soft key to enter the dialing page, press  to select the held call, and press the **Send** soft key to start the three-way call.



- What you can do during a three-way call

1. **Split** softkey: You can split a three-way call into multiple independent calls, press  or  to switch between calls.

2. **Hold** softkey: You can put two other parties on hold and press the **Resume** softkey to resume the three-way call.

3. **Management** Softkey: Enter the Management page to perform the following operations on the other two parties' calls:

-
- 1) **Delete** softkey: deletes the selected conference member.
 - 2) **Hold** softkey: Holds the selected conference member.
 - 3) **Return** softkey: return to the previous level interface.
 4. **Mute** button: so that the other two parties can not hear your own voices, and the other two parties can still make a call.
 5. **Hang up** soft key: ends the meeting.

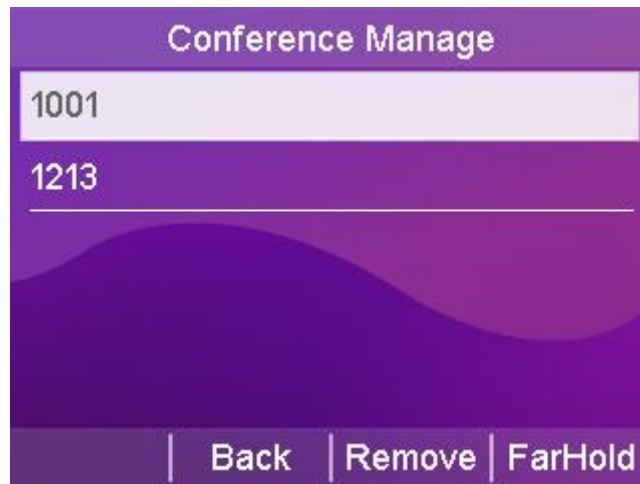

- Change the conference type on the Web UI

1. On the webGUI, tap Account (A) -> Advanced (j).
2. Change the meeting type to network meeting.
3. Enter the meeting URI (please provide server that requires supporting network meetings for the corresponding account).
4. Click Submit to save the configuration.

SIP Registration Retry Timer (0~1800s)	30
Conference Type	Network Conference
Conference URI	63000
Directed Call Pickup Code	
Group Call Pickup Code	
Unregister When Reboot	Disable
RFC 2543 Hold	Disable
Synchronize server time	Enabled

Cancel(c)
Confirm(s)

Update

The phone can be upgraded to the latest version via the Web. The latest version can be downloaded from the official website or contact your dealer for a copy.

- Upgrade Firmware Version via Web

1. Through the web interface, click **Settings->Upgrade->Upgrade Firmware**, select the version that needs to be upgraded and click Upgrade.
2. Disconnection of power and network is prohibited during the upgrade process, otherwise irreversible problems may occur, such as inability to power on the phone.

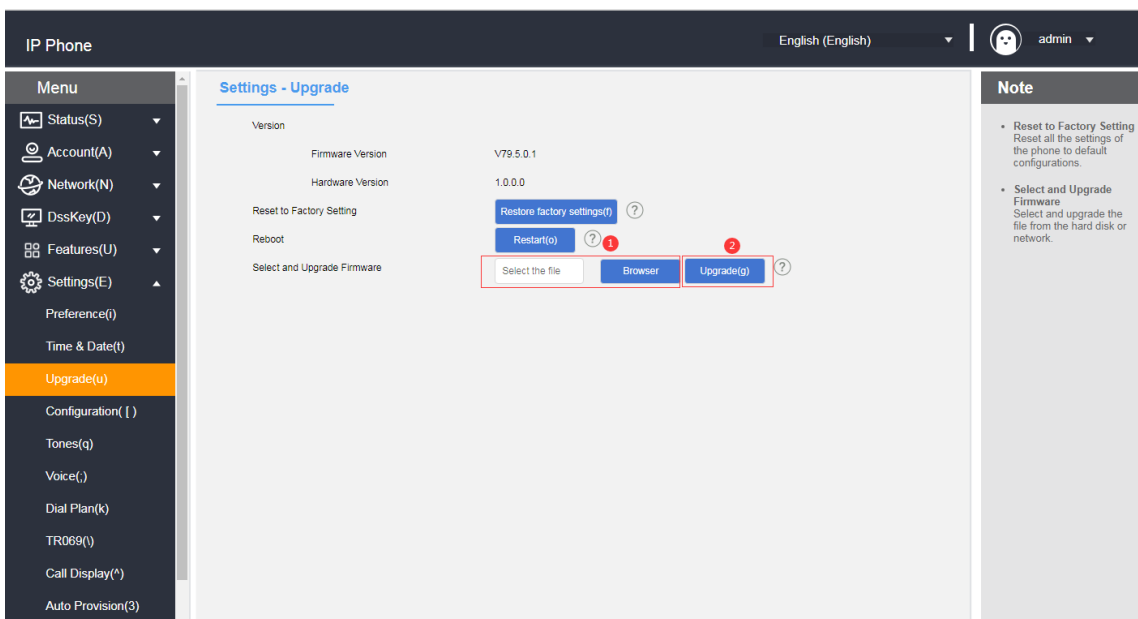

Upload ringtones

The phone can upload customized ringtones via the Web.

- Upload customized ringtones via Web

1. Click **Settings->Priority->Load Ringtones** through the web interface.
2. Select the ringtone you want to upload in the Load ringtone item, click the Import button to import the ringtone (maximum ringtone limit:100KB).
3. After successful upload you can select it in the ringtone type option.

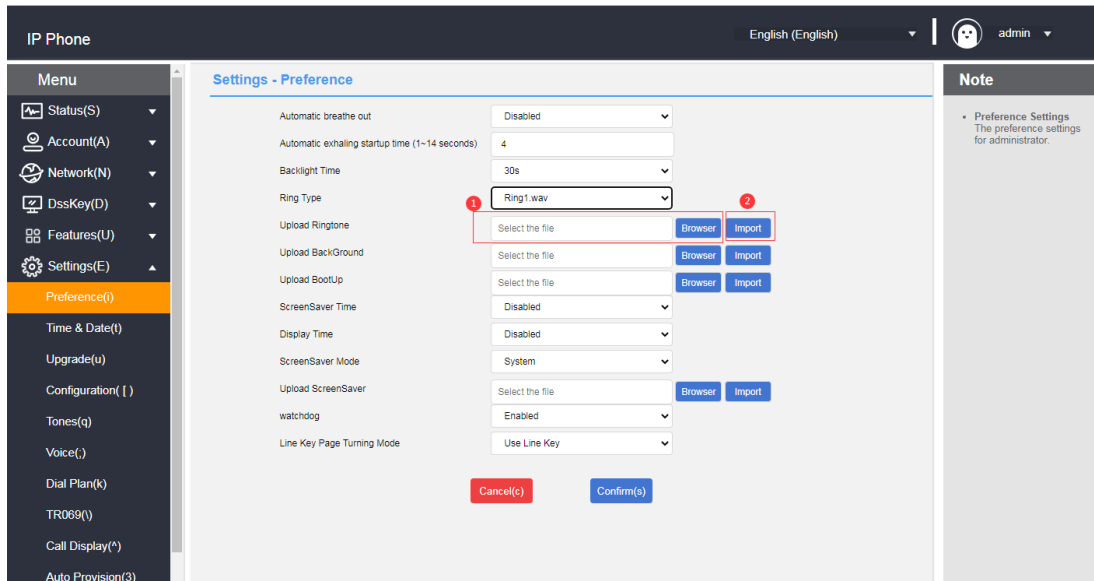

Capture & Diagnose

The phone can be used to capture packets via the Web for professionals to easily locate phone problems.

- Grabbing packets from the web

1. Click **Network Configuration->Diagnostics** from the web page.
2. Select the packet capture method.
3. Click Start and download the file after the packet capture is finished.

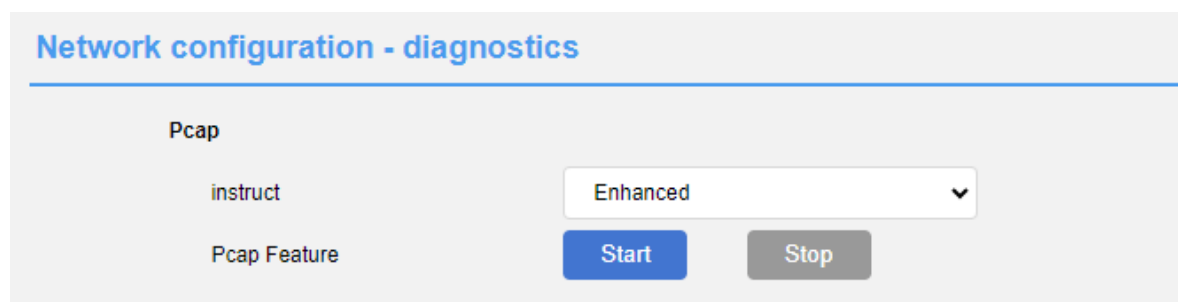

- Diagnosing the network through the web

1. Click **Network Configuration->Diagnostics** from the web page.
2. Select the diagnostic command.
3. Click Submit to check the network status.

- Network diagnostics via handsets

1. The phone clicks **Menu->Settings->Basic Settings->Diagnostics->Network**.

2. Select Ping or Route Trace, enter the IP address or URL and click Start.

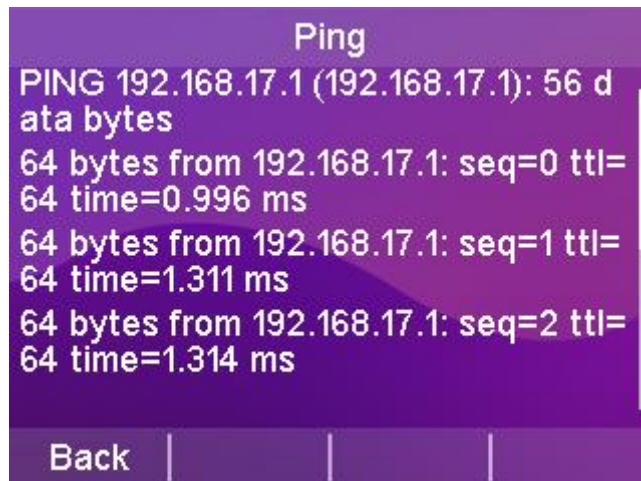

Scheduled reset

The phone can be set to restart automatically via the web page, disabled by default.

- Configure automatic reboot via web page

1. Click **Settings->Time Management** through the webpage.
2. Configure the restart program.
 - a) Auto Restart Enable/Disable;
 - b) Configure the restart time;
 - c) Configure the restart date;
3. Click Submit to save the configuration.

Settings - Time Manager

Auto Reboot

Auto Reboot

Time : :

Weekly

Sun

Mon

Tue

Wed

Thu

Fri

Sat

configuration management

The phones can import/export configurations via web page, and the configurations can be common for the same model.

- Configuration management via web page

1. Click Settings->Configuration **Management** from the web page.
2. Click the Export button to export the bin configuration file.
3. Select a configuration file and click Import to import the configuration.

Settings-Configuration

BIN Configuration

Export or Import Configuration

Note: Exported data contains only modified data, default factory Settings will not be

exported;

Advanced Features

This chapter introduces the advanced features of the telephone as follows:

- [BLF](#)
- [walkie-talkies](#)
- [multicast](#)
- [text](#)
- [TR069](#)
- [SIP Configuration](#)
- [Action URL](#)
- [Trusted Certificates](#)

BLF (Busy Lamp Field)





You can use the BLF feature to monitor the account usage status of a particular user. For example, you can configure a BLF key on the phone to monitor a coworker's account usage status (busy or idle). When a coworker's account is busy, the BLF key's LED lights turns red to indicate that the coworker's account is busy.

Configure the BLF function:

You can configure the function of BLF monitoring on the phone, and the monitored phone does not need to do the configuration.

Configuring the BLF key

- Configure BLF keys through the phone interface
- 1. Press **Menu** → **Function** → **Programmable Key**.
- 2. Select the account key for which you need to set the BLF.

3. Press  or  to toggle and select BLF in the **Type** field.
4. Press  or  to toggle and select the appropriate account in the **Account ID** area.
5. (Optional) Enter the label to be displayed in the standby screen in the **Label** field.
6. Enter the number to be monitored in the **value** field.
7. (Optional) Enter the intercept feature code in the **extension number** field. sip server support is required.
8. Press the **Save** soft key to save the operation or the **Return** soft key to cancel the operation.

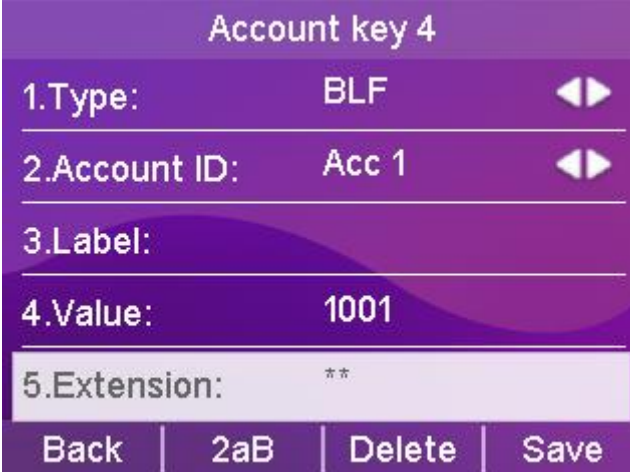

- Setting the BLF key through the web interface

1. Web page click **Programmable Keys -> Account Key**.
2. Select the account key for which you need to set the BLF.
3. Select BLF in the **Type** drop-down box.
4. Enter the account you want to monitor in the **Value field** input box.
5. (Optional) Enter the label to be displayed in the standby screen in the label input box.
6. Select the corresponding account in the **Account** drop-down box.
7. (Optional) Enter the Intercept Characteristic Code in the **extension number** entry box. sip server support is required.
8. Click **Submit** to save the operation or **Cancel** to abandon the operation.

Key	Type	Value	Label	Account	Extension
Line Key1	BLF	8007	BLF8007	Account1	**
Line Key2	Account			Account2	
Line Key3	Account			Account3	
Line Key4	Account			Account4	
Line Key5	N/A				
Line Key6	N/A				
Line Key7	N/A				
Line Key8	N/A				
Line Key9	N/A				
Line Key10	N/A				
Line Key11	N/A				
Line Key12	N/A				

Using the BLF Function

The BLF key is used in the following way:

- **Calling the monitored account.**

When the monitoring account is idle, press the BLF key and the phone calls out the monitoring account.

- **Intercepting calls from monitored accounts.**

When an incoming call is received from a monitored account, the LED of the BLF key corresponding to the monitored account turns red. If the extension number is configured as an Intercept Feature Code, the call from the monitored account is answered when the BLF key is pressed.

Walkie-talkies

By setting the account number key as the intercom function, you can speed dial the called number that has been set when pressing the account number key, and quickly connect to your secretary or operator in an office environment. The called party of the intercom will automatically answer the intercom call.

Setting the intercom function buttons

Before using the intercom you need to set up the account key function as an

intercom key, see Programmable Keys for details on how to set this up, for help please contact your network administrator.

Intercom function setting

- Turn on the intercom through the handset interface

1. Press **Menu->Features->Intercom**.
2. Press  or  to select the intercom function.
3. Press the **Toggle** soft key to turn the function on/off.
4. Press the **Save** soft key to save.

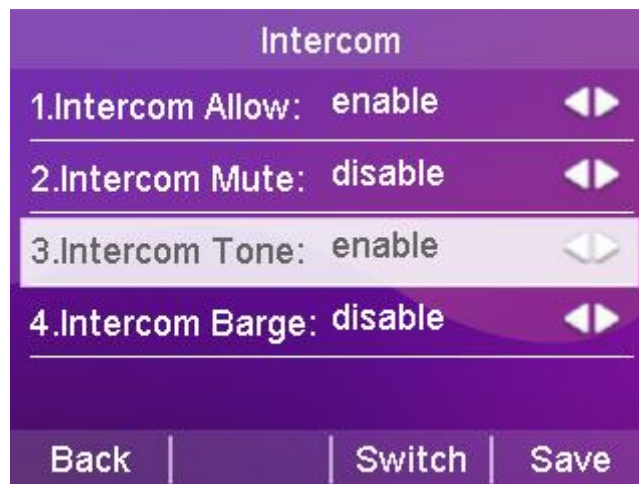

- Turning on the intercom through the web interface

1. Log in to the phone page by IP address.
2. Click **Function (U) -> Intercom (n)**.
3. Select different functions in the type selection.
4. Press **Submit** to save when you have finished selecting.

Features - Intercom

Intercom

AllowIntercom	Enabled	?
IntercomMute	Disabled	?
IntercomTone	Enabled	?
Intercom Barge	Disabled	?

Cancel(c)

Confirm(s)

Intercom function description





functionality	clarification
Enable walkie-talkies	Enable or disable the intercom function.
Walkie Talkie Mute	Enable or disable mute on the handset for incoming intercom calls.
intercom tone	Enable or disable the intercom tone for incoming intercom calls.
Intercom Intervention	Enable or disable access to incoming intercom calls while you are on a call.

multicast

Multicast allows you to send time-sensitive announcements to each member of a multicast group simply and quickly. Send RTP streams to pre-configured multicast addresses via multicast keys or multicast lists set on the phone. By setting up listen multicast addresses on other phones, the phones can listen to and play RTP streams sent from the multicast addresses. The multicast process does not involve SIP signaling. Phones can be set to listen to up to 31 multicast addresses.

Multicast Configuration

- Configuring Multicast Keys via the Handset

1. Press **Menu** → **Function** → **Programmable Key**.
2. Select the account key for which you need to set up multicast.
3. Press  or  to toggle and select Key Event in the **Type** area.
4. Press  or  to toggle and select Multicast in the **Key Type** area.
5. (Optional) Enter the contents of the standby screen display in the **label** area.
6. Enter the multicast address IP address + port number in the **value** field, IP range 224.0.0.0-239.255.255.255.
7. Enter the appropriate channel number in the channel area: 0-30.
8. Press the **Save** soft key to save the operation or press the **Return** soft key to cancel the operation.

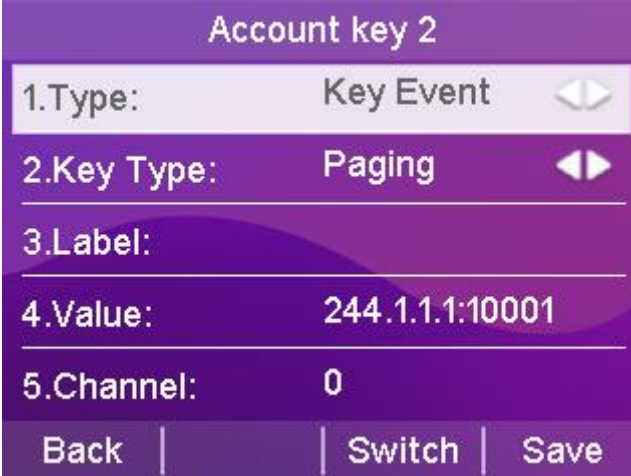

Account key 2	
1.Type:	Key Event
2.Key Type:	Paging
3.Label:	
4.Value:	244.1.1.1:10001
5.Channel:	0
Back Switch Save	

- Configuring Multicast Keys via the Web Interface



1. Web **Programmable Keys** → **Account Key**.
2. Select the account key for which you need to set up multicast.
3. The **Type** area drop-down box is set to Multicast.
4. The **Value field** input box is filled with the multicast address IP address + port number, IP range 224.0.0.0-239.255.255.255.
5. (Optional) Enter the contents of the standby screen display in the **label** area.
6. Enter the appropriate channel number in the **extension number** area: 0-30.

7. When finished, click **Submit** to save the operation or **Cancel** to abandon the operation.

Key	Type	Value	Label	Account	Extension
Line Key1	Multicast	224.1.1.5:5080			0
Line Key2	Account			Account2	
Line Key3	Account			Account3	
Line Key4	Account			Account4	
Line Key5	NIA				
Line Key6	NIA				
Line Key7	NIA				
Line Key8	NIA				
Line Key9	NIA				
Line Key10	NIA				
Line Key11	NIA				
Line Key12	NIA				

Multicast List Configuration

- Configure multicast lists through the phone

1. Press **Menu->Functions->Multicast List**.
2. Press  or  to select the appropriate group.

The label defaults to empty before configuration.

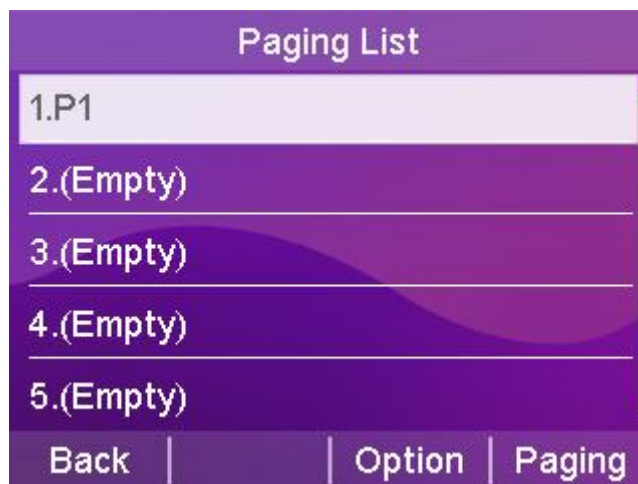

3. Press the **Options** soft key, and then press the **Edit** soft key.
4. Enter the multicast IP address and port number in the **address** area (for example: 224.5.6.20:10008).
5. Enter the group name in the **label** area.
6. Enter the appropriate channel number in the channel field.

Valid channels are numbered 0 through 30.

7. Press **Save** Software to save the operation.
8. Repeat steps 2-7 to add more groups.

- Configuring Multicast Lists via the Web

1. Web **Address Book** → **Multicast Address** → **Multicast List**.
2. Fill in the **Multicast Address** input box with the multicast address IP address + port number (e.g., 224.5.6.20:10008).

Index	Multicast IP	Label	Channel
1	224.5.6.20:10008		1
2			0
3			0
4			0
5			0
6			0
7			0
8			0
9			0
10			0

Cancel(c) Confirm(s)



3. Enter the group name in the **label** area.
4. Select the appropriate channel number in the Channel drop-down box.
5. Click **Submit** to save the operation when finished.

- Configure multicast codecs via web page

1. Web **functions** → **Basic information**.
2. Select: PCMA, PCMU, G722, G729 in **Multicast Codec**.
3. Click **Submit** to save the operation when finished.

If the codec is G722 then the phone is sending a high definition voice stream and the LCD interface displays HD (High Definition icon)

- Deleting a multicast group through the phone interface

1. Press **Menu->Functions->Multicast List**.
2. Press  or  to select the appropriate group.
3. Press the **Options** soft key, and then press the Delete soft key.

The phone's LCD screen prompts "Delete Group?" .

4. Press the **OK** soft key to delete.

To delete all multicast groups, press the **Delete All** softkey.

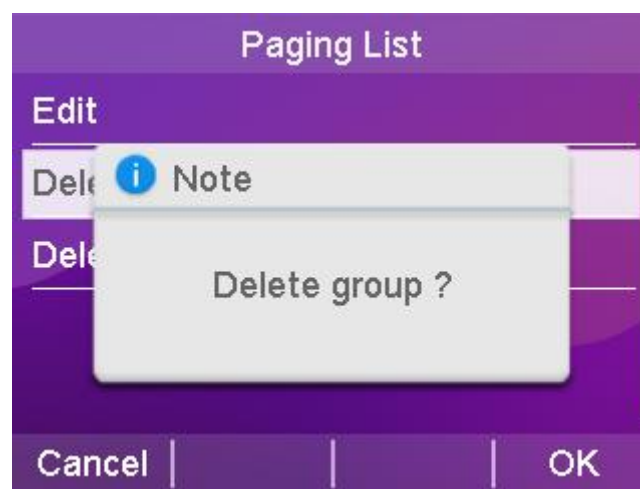

You can also set the processing method of RTP streams received by the phone via Web, which is categorized into Paging Intervention, Penetrating DND and Paging Priority, Configuration Path: **Web Contacts → Multicast Address**.

Directory-Multicast IP

Multicast Listening

Paging Barge	Disabled
Ignore DND	Disabled
Paging Priority Active	Disabled

IP Address	Listening Address	Label	Channel	Priority
1			0	1
2			0	2
3			0	3
4			0	4
5			0	5
6			0	6
7			0	7
8			0	8
9			0	9
10			0	10

Paging List

1. **paging intervention**: if there is a multicast during the call, if the current multicast priority is lower than the call priority, the phone will automatically ignore the multicast; disable it to ignore all the multicasts, the range is 1-31. for example, if

you set the priority to 1, then it will ignore multicasts with the priority of 2-31.

2. **Penetrating DND:** If the phone opens Penetrating DND, priority 3; when the phone opens DND Mode, multicasts with priority greater than or equal to three can be answered normally.

3. **Paging Priority:** If you turn on Paging Priority, when the phone is listening to a multicast RTP stream with priority 5, and a multicast RTP stream with priority 3 is sent at this time, the phone automatically receives a multicast RTP stream with priority 3.

Accept multicast RTP streams

You can set the phone to receive multicast RTP streams sent from pre-configured multicast addresses. the multicast process does not involve SIP signaling. Up to

Description RTP multicast listening is played in hands-free mode by default, if you want to play through other modes (hands-free, joystick or headset), please consult your system administrator.

31 different multicast addresses can be configured to listen on the phone.

1. **paging intervention:** if there is a multicast during the call, if the current multicast priority is lower than the call priority, the phone will automatically ignore the multicast; disable it to ignore all the multicasts, the range is 1-31. e.g. set the priority to 1 to ignore the multicasts of priority 2-31.

2. **Penetrating DND:** If the phone opens Penetrating DND, priority 3; when the phone opens DND Mode, multicasts with priority greater than or equal to three can be answered normally.

3. **Paging Priority:** You can enable or disable Paging Priority, a feature that determines how the phone handles newly received multicast RTP streams when it is currently engaged in a multicast session. If you enable paging priority, the phone automatically ignores multicast RTP streams with low priority, receives multicast RTP streams with high or equal priority, and places the current multicast

session on hold. If paging priority is disabled, the phone will automatically ignore all received multicast RTP streams.

- Set the multicast address to listen to via the web page:

1. Click Address Book -> Multicast Address.
2. Select the appropriate value in the Paging Intervention drop-down box.
3. Select Enable in the Paging Priority drop-down box.
4. In the Listening Address field, enter the multicast address to which you are listening: IP address and port number (for example: 224.5.6.20:10008).
5. (Optional) Enter a label in the label area. When a multicast RTP stream is received, the LCD interface displays the label for that multicast.
6. Select the appropriate channel in the Channel drop-down box, the default is 0.
7. Click Submit to save the operation.

Directory-Multicast IP

Multicast Listening

Paging Barge: 3

Ignore DND: Disabled

Paging Priority Active: Enabled

IP Address	Listening Address	Label	Channel	Priority
1	224.5.6.20:10008		0	1
2			0	2
3			0	3
4			0	4
5			0	5
6			0	6
7			0	7
8			0	8
9			0	9
10			0	10

Paging List

Description The priority of the listening address is predefined: 1 is the highest priority and 31 is the lowest priority. You can only set the multicast address to listen to through the web interface.

Multicast Usage

Phone A sets up account 1 for multicast and account 2 for multicast list, and

phones B, C, D, etc. set up listening addresses.

1. Multicast key sending: when the phone A is in standby state, press the account 1 multicast key, the pre-configured listening phone will receive the multicast RTP stream; when the phone A presses the hold key, the receiver will automatically hang up the multicast RTP session, and then press the resume key to restore the held multicast. Pressing Hangup ends the multicast RTP session.

2. Multicast list sending: press Multicast list in standby state, select the option you need to multicast and press Multicast, or press Menu→Function→Multicast list in standby state.

Caveats:

1. Multicast RTP streams are unidirectional and can only go from the sender to the receiver. when the phone is in a call. initiating a multicast RTP session the current call is on hold.

2. multicast does not generate call records.

Message

Text message

The IP phone can send and receive text messages. When receiving a new text message, the phone will emit a beep, the power indicator will flash red slowly, the LCD interface will indicate "n new text messages" (n means the number of unread text messages, for example: 1 new text message), and the icon of unread text message will be displayed. The icon  is displayed for unread text messages.

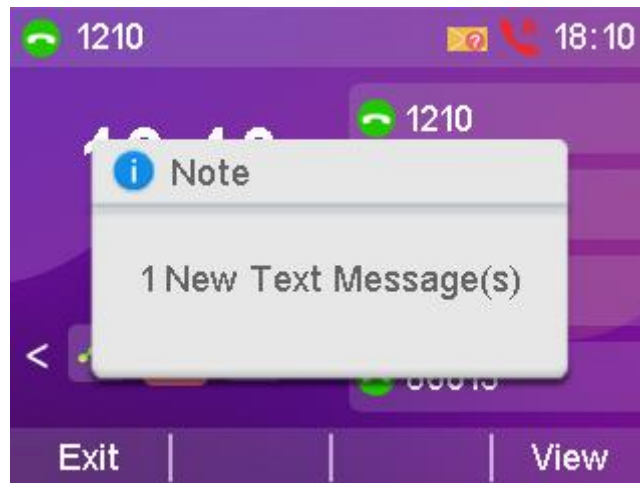

SMS messages can be stored in the Inbox, Sent, Outbox and Drafts boxes, each with 100 messages. If the number of messages exceeds 100, the oldest messages are deleted.

- Read the text message:

1. Press **Menu->Messages->Text Messages->Inbox**.
2. Select the message you want to read and press the **View** soft key.

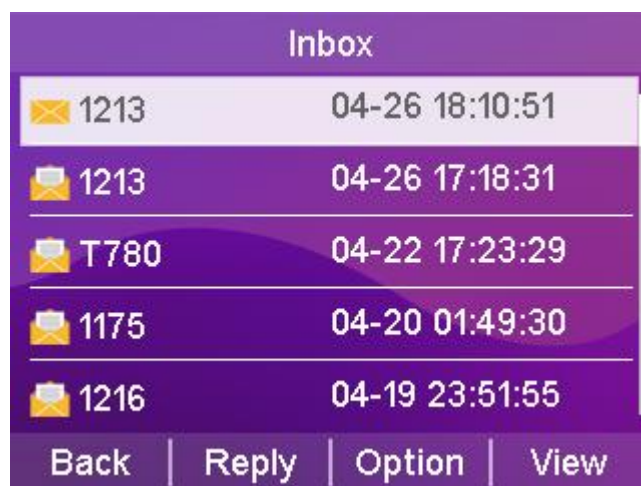

Description If the phone prompts to receive a new text message, you can simply press the **View** soft key to read it.

- Sends a text message:

1. Press **Menu->Message->Text Message->New Message**.

2. Compose a new message and press the **abc** soft key to switch the input method.

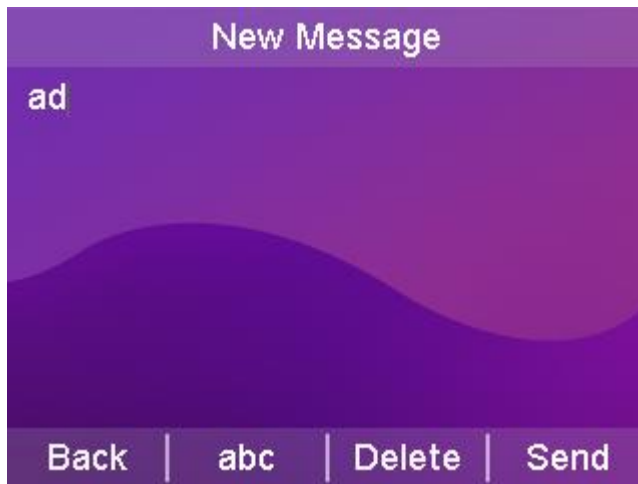

3. Press the Send soft key.

4. (Optional) Press the **Toggle** soft key to select the sending account in the **From** area.

5. Enter the recipient's number in the **Send To** field.

6. Press the Send soft key to send a message or the Return soft key to cancel.

- Sending text messages through the web interface

1. Log in to the web user interface.

2. Click **Function (U)->Short Message (9)**.

3. Select the sending account.

4. Enter the sending number.

5. Fill in the send content.

6. Click the **Submit** button to send the short message.

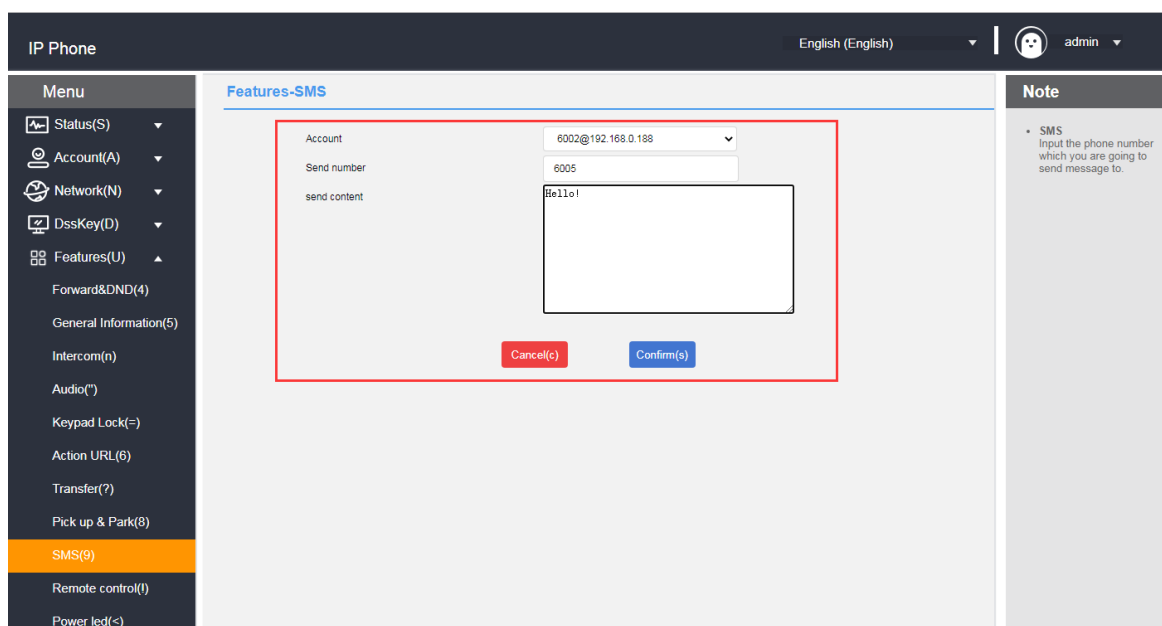

- Respond to the text message:

1. Press **Menu->Messages->Text Messages->Inbox**.
2. Select the message you want to reply to and press the **Reply** soft key.
3. Write the message and press **abc** to switch the input method.
4. When you are finished writing, press the **Send** soft key.
5. Check the **From** and **To** areas and press the **Send** soft key.

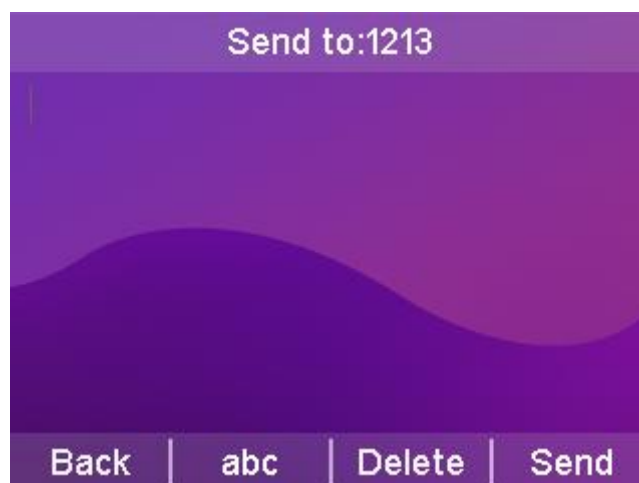

- Delete the text message:

1. Press **Menu->Messages->Text Messages->Inbox (Sent Messages, Outbox or Drafts)**.
2. Select the message to be deleted and press the **Options** soft key.

3. Select **Delete** and press the **OK** soft key to display "Delete Selected Information?" on the LCD screen. The LCD screen displays "Delete Selected Information?".

4. Press the **OK** soft key to delete and press the **Cancel** soft key to cancel.

To delete all SMS messages, press the **Options** soft key and select **Delete All**. For more information, see the steps above.

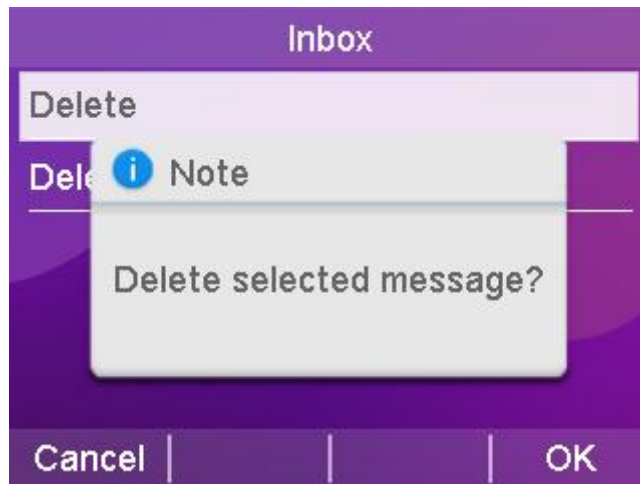

Description You can delete a message by pressing the **Delete** soft key directly after you have received and viewed a specific short message.

Voicemail

The handset can send and receive voice messages. You can subscribe to voice messages cached in the voice mailbox on the phone. This feature requires the server to be preconfigured. Not all servers support voicemail.

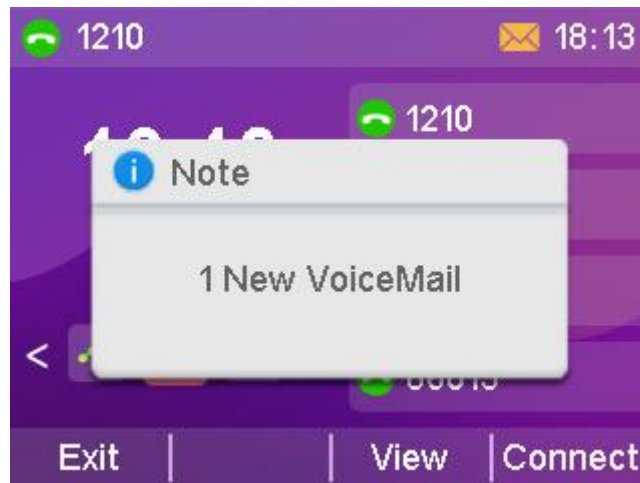

When a new voicemail is received, the power lamp of the phone blinks slowly in red, the LCD interface displays "N new voicemail messages" (N indicates the number of unread voicemails, e.g., 3 new voicemails), and the voicemail icon  is displayed.



- Send a voice message:

When the calling user is busy or inconvenient to answer the incoming call, you can leave him a message according to the server's voice prompts, and hang up the phone after leaving the message.

- Set the voice message access feature code through the phone interface:

1. Press **Menu->Message->Voice Message->Set Voice Feature Code**.
2. Press  or  to select the account to be set up.
3. Enter the voice message access feature code (e.g., *97).
4. Press the **Save** soft key to save the operation or the **Return** soft key to cancel

the operation.

- Listening to voice messages

1. Press the **SMS key** or call out the voice message access feature code after setting the voice feature code.
2. Just listen to the voice message according to the voice prompts.

- Viewing Voice Messages

1. Press **Menu->Message->Voice Message->View Voice Message**.
2. Select the account you want to listen to and press the **Connect** soft key to listen to the voice message.

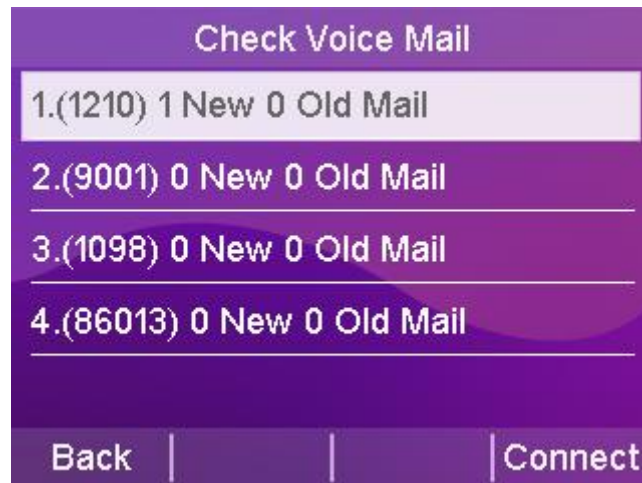

TR069

TR069 is TR069 is the communication protocol between CPE and ACS. TR069 is the communication protocol between CPE and ACS, through which CPE can complete initialization and operation management such as service activation, function setting, file uploading and downloading, and system testing.

TR069 workflow diagram for the phone:

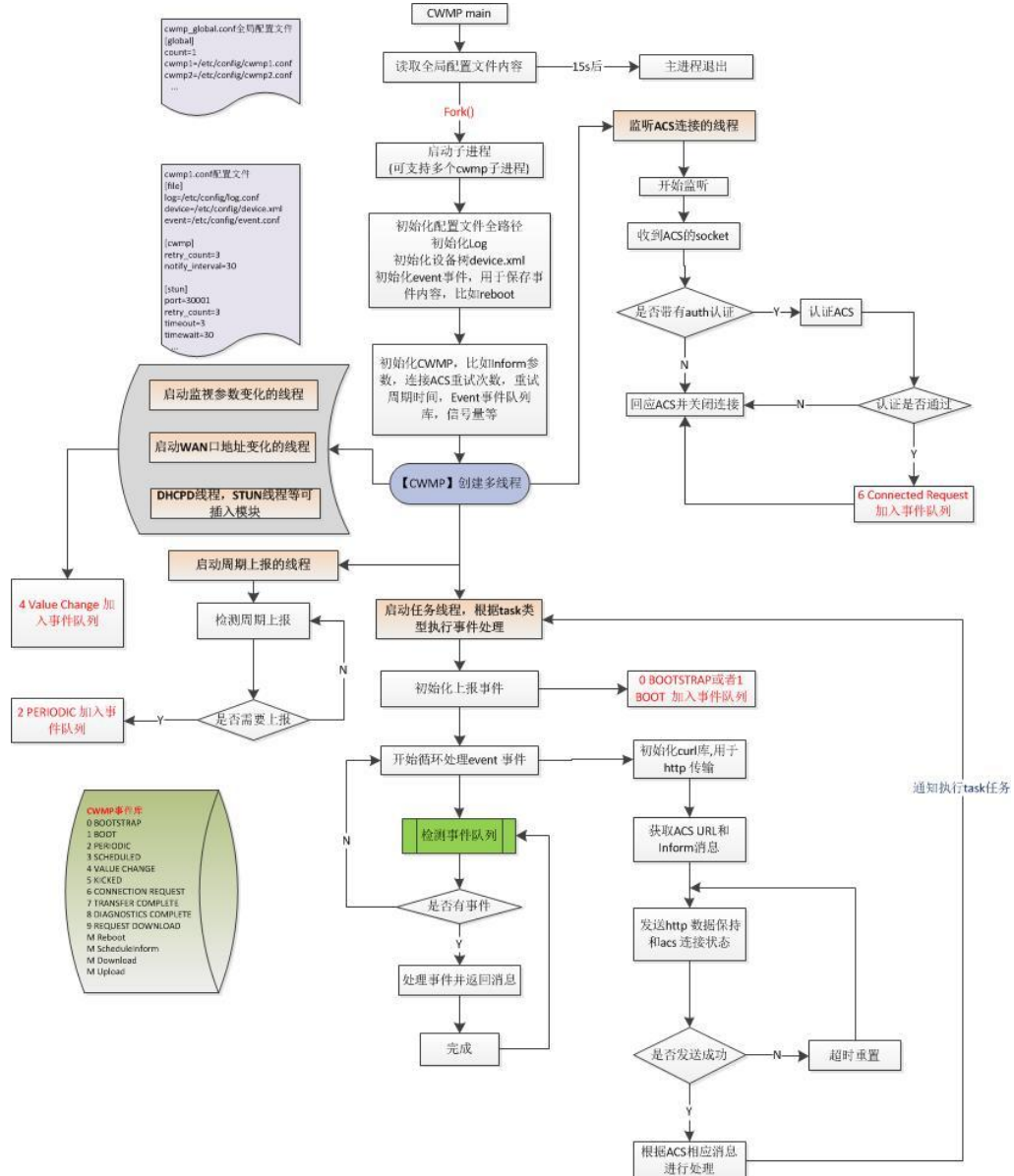

- Enabling TR069 through the web interface

1. Log in to the phone page by IP address.
2. Click **Settings (E)** -> **TR069 (I)**.
3. Enable TR069. Enter: user name, password, and server address.
4. Enable periodic notification, periodic notification interval, user name, and password.
5. Press **Submit** to save when you have finished selecting.

As pictured:

TR069

TR069

Enable TR069: Enabled ?

ACS Username: acs ?

ACS Password: ... ?

ACS URL: http://www.lvswitches.net:8000/otmc/acs ?

Enable Periodic Inform: Enabled ?

Periodic Inform Interval (seconds): 60 ?

Connection Request Username: acs ?

Connection Request Password: **** ?

Cancel(c) Confirm(s)

Automatic update

Automatic updates can deploy the same configuration for multiple phones at scale.

Preparatory step

Prepare the necessary documents:

The following steps need to be performed before auto-configuration can take place:

1. Get Boot boot file;
2. Get the CFG configuration file;
3. Obtain information about the phone;
4. Setting up a renewed environment.

Bootstrap files, configuration files can be obtained by contacting your dealer for template files;

- The way to view information about the phone:

MAC: The phone is viewed in standby mode by pressing the OK key.

Phone Model: Standby phone press **OK**→**More**→**Equipment**, the product name is the phone model.

- Bootstrap file description:

When the phone is auto-configured, it will first try to download the common.boot boot file, and according to the boot file, the phone will be guided to refer to the specified CFG configuration file. The sequence is shown below:

```

1  #!version:1.0.0.1
2  ## The header above must appear as-is in the first line
3
4
5  ##[SIP-T780]include:config <common_T780.cfg> 例子, 话机型号" SIP_T780 ", 对应配置文件 "common_T780.cfg"
6  ##[$MODEL]include:config <xxx.cfg>
7  ##[$MODEL,$MODEL]include:config "xxx.cfg"
8
9  ##include:config <common.cfg> 配置文件可以多个开启, 顺序如下:
10 ##include:config "mac.cfg"
11
12 specific_model.excluded_mode=1 话机默认开启排外模式, 配置文件优先下载对应MAC的配置文件, 如需关闭把1修改为0;
                                禁用模式下从上依次向下寻找, 下载第一个找到的配置文件。

```

- Profile Description:

Before you configure the phone, you need to get the CFG configuration file, common.cfg for the common configuration file, mac.cfg for the mac-based configuration file; you can also create your own needs according to their own needs of the configuration file such as account.cfg used to configure the phone account and so on.

The list of configuration support is as follows:

	element
Phone Configuration	Account, Heartbeat Service, DTMF, User Agent, Time, STUN, Network, Vlan, LLDP, CDP, Language, Signal Tone, QoS, Sound.
Function Configuration	Call Forwarding, Anonymous Calling, Intercom, TR069, Programmable Keys, DND, Hotline, Voice Mailbox, Keypad Lock, Action URL, Auto Update.
Other configurations	Upgrade the phone and pager configuration.

Example: If the phone needs to be upgraded to a specific version and the

language is set to Chinese, create a LanguageAndUp.cfg file, add the configuration and place it in the root directory of the server.

```
### Language ###
```

```
language_setting.languages = 0
```

Description If you set up an upgrade, the upgrade file must be in this directory or the upgrade will fail.

```
### Upgrade ###
```

```
static.firmware.url = ftp://192.168.17.xx/V2.0.0.3_IP Phone_rootfs.sqhfs
```

Automatic update procedure

HTTP(S) method update

To configure the server, run HFS.exe directly; after running it, place the configuration file directly in the environment root directory; The configuration file contains files such as xx.boot and xx.cfg.

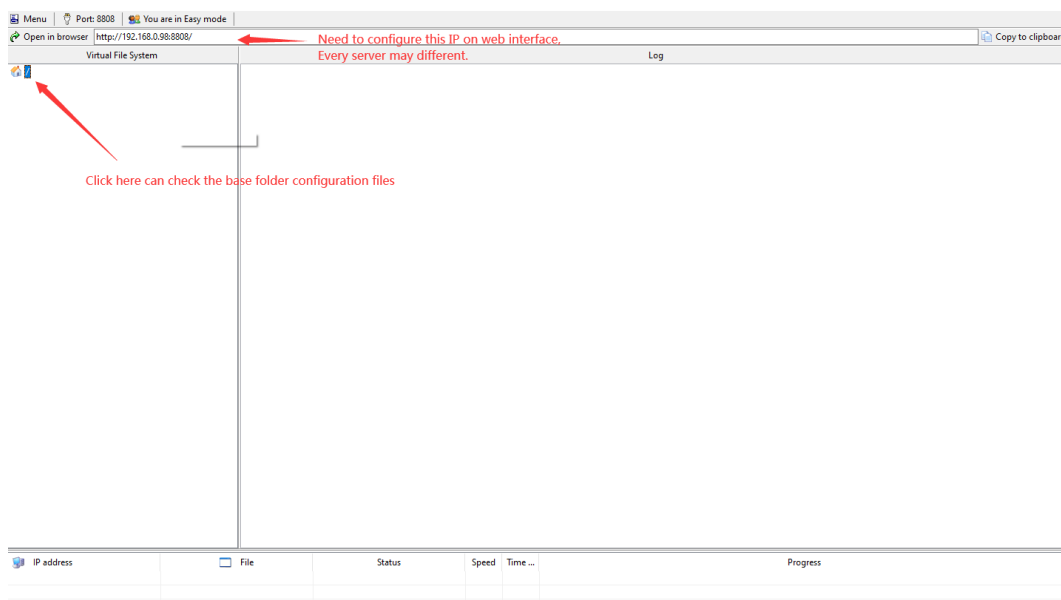

名称	修改日期	类型	大小
IME	2019/8/29 13:48	文件夹	
XML	2019/8/29 13:48	文件夹	
805ec059571d.cfg	2020/7/17 17:39	CFG 文件	1 KB
common.boot	2020/11/26 13:07	BOOT 文件	1 KB
common.cfg	2020/11/26 14:20	CFG 文件	20 KB
mac.cfg	2019/6/13 13:49	CFG 文件	21 KB
V2.0.0.3_T780_rootfs.sqhfs	2020/11/27 11:08	SQHFS 文件	10,418 KB

Root directory file map:

Setup Steps:

Web-side Settings(E)→Auto Update→Fill in http(s) address in Server Address e.g..
http(s)://192.168.17.xx to enable power-on startup; automatically configure the
information to be updated after reboot.

Settings - Auto Update

Auto Provision

Auto Provision: Enabled

PNP activation: Disabled

DHCP activation: Enabled

DHCP option value: 66

Server URL: http://192.168.17.59:8088

User Name:

Password:

Get profile timeout (seconds):

Power on and start: Enabled

Repetition period: Enabled

Interval (minutes): 1440

Week by week: Disabled

Update interval (0-12 weeks): 0

Inactive time period (0 ~ 120min): 0

Time: 00 : 00 - 00 : 00

Weekly: Sun Mon Tue Wed Thu Fri Sat

Update now: Update now

Cancel(e) Confirm(s)

FTP/TFTP update

Configure the server, directly run IPOP.exe to enable FTP/TFTP inside the service, you can also use 3CDaemon, TFTP32, etc. as the server; run the configuration file directly in the root directory of the environment; the configuration file contains xx.boot and xx.cfg and other files. The configuration steps are shown

in the following figure:

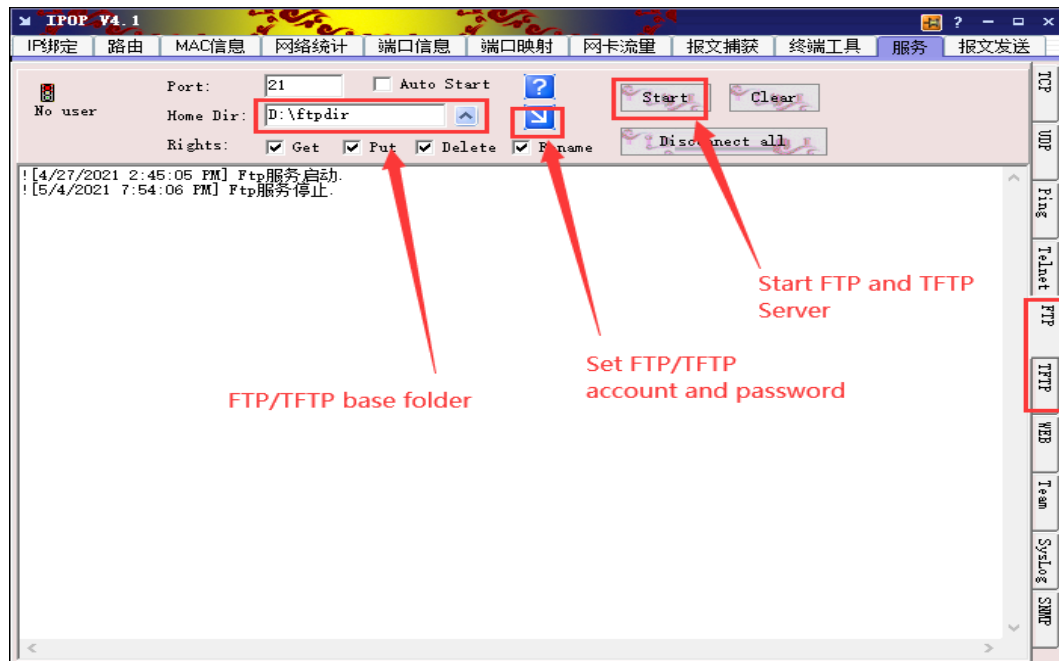

Setup Steps:

Web-side Settings (E)→Auto Update→Fill in the ftp/tftp address in Server Address
e.g. ftp://192.168.17.xx/ to enable power-on startup; automatically configure
information update after reboot.

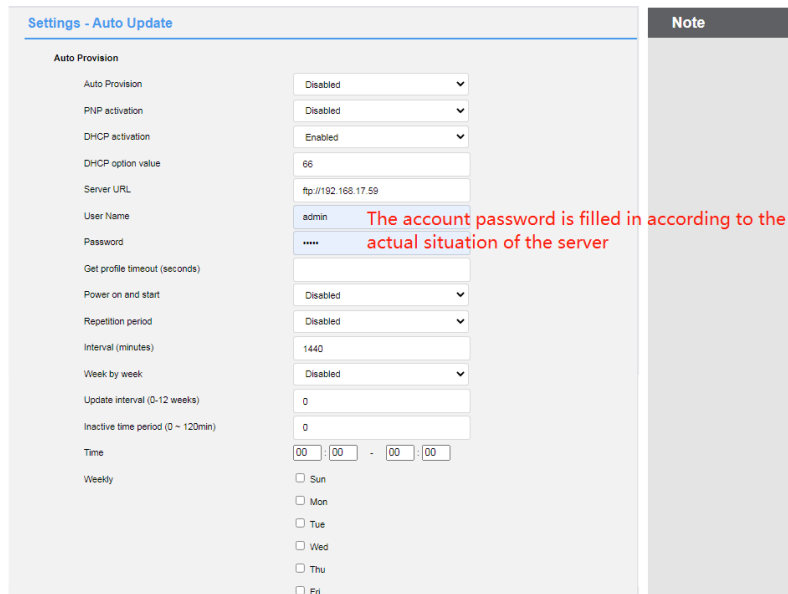

Remote control

Used to control the configuration related to remote XML push.

- Configure remote control via web page

1. Log in to the web user interface.
2. Click **Function (U) -> Remote Control (i)**.
3. Configure remote control.
 - a) XML push server address;
 - b) User name: Set the XML push server address user name;
 - c) Password: Set the XML push server address password;
 - d) SIP NOTIFICATION: Enable/disable phone call SIP NOTIFY message

processing XML push;

e) Blocking XML push in calls;

f) Allow control IP list: Multiple IPs are separated by ",", allowing all IPs to fill in

any;

g) CSTA control;

Features-Remote control

Push XML Server IP Address	<input type="text" value="192.168.17.32"/>
User Name	<input type="text"/>
Password	<input type="password"/>
SIP Notify	<input type="text" value="Disabled"/>
Block XML in Calling	<input type="text" value="Disabled"/>
Allow control IP list	<input type="text" value="any"/>
CSTA control	<input type="text" value="Disabled"/>

4. Click the **Submit** button to save the changes.

Note: If you perform operations related to calls through remote control (such as making call, connecting, and hanging up), the phone will display a box asking for the customer's authorization to prevent theft. If the control IP address list is modified after authorization or fails after the device is restarted, you need to re-authorize the IP

address list. As shown below:

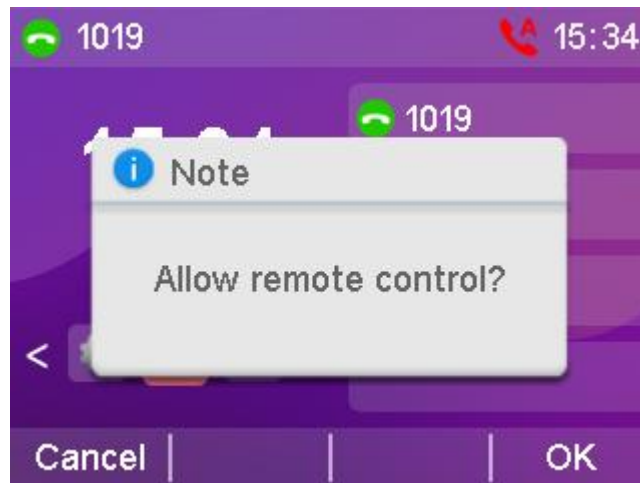

XML can perform the following operations:

Displaying menu options, displaying text prompts, collecting user submissions, downloading address books from the server, prompting the phone for status information, notifying the phone to perform a series of commands, modifying phone configuration (e.g., registration, etc.), displaying text prompts in a fixed format on the interface, displaying graphic prompts on the interface, displaying menu items in graphic format, and customizing function softkeys.

- Server pushes XML to phone

Remote control application, the server can push XML to the phone by POST, and the end user does not need any action. This time not to do the server to build the introduction of interested parties can learn a programming language. Here we take the PHP environment as an example to push the XML file to the terminal of the phone:

The file format is as follows, just access it after the configuration is complete.

```
<?php #
function pushtophone($server,$phone,$data){
    $xml = "xml=". $data;
    $post = "POST / HTTP/1.1\r\n";
    $post . = "Host: $phone\r\n" ;
    $post . = "Referer: $server\r\n";
    $post . = "Connection: Keep-Alive\r\n" ;
    $post . = "Content-Type: text/xml\r\n";
    $post . = "Content-Length: ".strlen($xml)." \r\n\r\n".
    $fp = @fsockopen ( $phone, 80, $errno, $errstr, 5);
    if($fp){
```

```
        fputs($fp, $post.$xml); flush();
        fclose($fp);
    }
}
$xml = "<IPPhoneTextScreen Beep=\"yes\">\n";
$xml . = "<Title>Push test</Title>\n";
$xml . = "<Text>This is a test for pushing text to a phone.</Text>\n";
$xml . = "</IPPhoneTextScreen>\n" ;
pushtophone("192.168.17.xx", "192.168.17.xx",$xml);

? >
```

SIP Configuration

SIP Session Timer

SIP session timers T1, T2 and T4 are SIP transaction layer timers defined in RFC 3261.

- Configure SIP session timer via web page (only via web page)

1. Log in to the web user interface.
2. Click **Settings (E) -> SIP Configuration (*)**.
3. Configure T1, T2 and T4.
4. Click the **Submit** button to save the changes.

SIP Session Timer T1: Timer T1 is an estimate of the round-trip time (RTT) of a transaction between a SIP client and a SIP server.

SIP Session Timer T2: Indicates the maximum retransmission time for any SIP request message. the retransmission multiplication of T1 will continue until the retransmission time reaches the value of T2.

For example, a user registers a SIP account and sets the values of Timer T1 and Timer T2 respectively (Timer T1:0.5, Timer T2:4). the SIP registration request message will be retransmitted between the phone and the SIP server. The retransmission multiplication of timer T1(0.5) will continue until the retransmission

time reaches timer T2(4). The total registration request retry time will be less than 64 times T1($64 * 0.5 = 32$). The retransmission intervals are in order:0.5s, 1s, 2s, 4s, 4s, 4s, 4s, 4s, 4s, 4s, 4s, 4s, 4s, 4s, 4s, 4s, 4s.

SIP Session Timer T4: Indicates how long it takes for the network to clear messages between the SIP client and server.

Setting-The SIP configuration

power save mode

SIP Session Timer T1 (0.5-10 SEC)	0.5
SIP Session Timer T2 (2-40 SEC)	4
SIP Session Timer T4 (2.5-60 SEC)	5
Local SIP Port	5060
The TLS SIP port	5061

Cancel(e) Confirm(s)

Native SIP ports vs. TLS SIP ports

If NAT is not enabled, the port number is displayed in the header of the SIP message for via and contact. If NAT is enabled, the phone will use the port and address for NAT in the header fields for via and contact, but will still use the configured source port.

- Configuring Local SIP Ports and TLS SIP Ports via Web Page

1. Log in to the web user interface.
2. Click **Settings (E)** -> **SIP Configuration (*)**.
3. modify the local SIP port and TLS SIP port.
4. Click the **Submit** button to save the changes.

Setting-The SIP configuration

power save mode

SIP Session Timer T1 (0.5-10 SEC) 0.5

SIP Session Timer T2 (2-40 SEC) 4

SIP Session Timer T4 (2.5-60 SEC) 5

Local SIP Port 5060

The TLS SIP port 5061

Cancel(s) Confirm(s)

Action URL

The Action URL function is mainly used for the phone to report its own behavior to the computer, an action generates a URL on the phone side, and the actions on the phone side include incoming call, outgoing call, call transfer, etc. The web management interface lists all the supported actions, and each action corresponds to a user-defined URL. when an action is generated, such as an incoming call, the phone and sends out an HTTP/HTTPS GET to the computer of the corresponding URL, so as to achieve the purpose of reporting its own actions. HTTP/HTTPS GET to the computer to report the action.

This function works in conjunction with the Action URI to enable mutual control between the phone and the computer.

URL format: `http(s)://server address/help.xml?mac=$mac`

Enables actions to be reported to the server

Enables reporting of server actions and a list of variables supported by each action:

Reportable actions	clarification	Supported Variables
Startup complete.	When phone startup is complete	\$mac \$ip \$model \$firmware (base)
registered	When SIP account registration is successful	\$mac \$ip \$model \$firmware \$local
unregistered	When the SIP account is not registered	<i>ibid</i>

Registration Failure	When SIP account registration fails	<i>ibid</i>
Drop the handle.	When the handle is hanging	\$mac \$ip \$model \$firmware (<i>base</i>)
Pick up the handle.	When the handle is off	<i>ibid</i>
When there is an incoming call	When the phone calls	\$mac \$ip \$model \$firmware \$active_url \$active_user \$active_host \$local \$remote \$display_local \$display_remote \$call_id \$callerID \$calledNumber (call related)
send a call	When the phone dials	<i>ibid</i>
establish a session	When the call establishes a session	<i>ibid</i>
end a call	At the end of the call	\$mac \$ip \$model \$firmware
Turn on Do Not Disturb	When Do Not Disturb is turned on	<i>ibid</i>
Turn off do-not-disturb	When you turn off Do Not Disturb	<i>ibid</i>
Turn on unconditional forward	When unconditional call forwarding is turned on	<i>ibid</i>
Close unconditional forward	When unconditional call forwarding is turned off	<i>ibid</i>
Open up a busy forward	Turn on the busy forward	<i>ibid</i>
Turn off busy forward	Close when busy	<i>ibid</i>
Turn on no-answer forward	Turn on No Answer Forward	<i>ibid</i>
Turn off no-answer forward	Turn off no answer forward.	<i>ibid</i>
transfer a call	When a call transfer occurs	\$mac \$ip \$model \$firmware

		\$active_url \$active_user \$active_host \$local \$remote \$display_local \$display_remote \$call_id \$callerID \$calledNumber
Blind transfer	blind transfer	<i>ibid</i>
Advisory Transfers	Consultation transfer	<i>ibid</i>
Call hold	hold a call	<i>ibid</i>
Discontinue holding	When canceling the call holding	<i>ibid</i>
mute	When mute is on	<i>ibid</i>
unmute	When mute is canceled	<i>ibid</i>
unanswered call	When there is a missed call	<i>ibid</i>
IP Change	When changing the IP address of the phone	<i>ibid</i>
Idle Entry Call	When the phone enters a call from the idle state	\$mac \$ip \$model \$firmware \$active_url \$active_user \$active_host \$local \$remote \$display_local \$display_remote \$call_id \$callerID \$calledNumber
Calls go into idle	When the phone goes from talking to idle	<i>ibid</i>
Rejection of calls	When rejecting an incoming call	<i>ibid</i>
Answer new calls	When answering a new call	<i>ibid</i>
transfer failure	When call forwarding fails	<i>ibid</i>
Transfer complete.	When call forwarding is complete	<i>ibid</i>
forward call	forward call	<i>ibid</i>
Auto-provision	When the automatic update is complete	<i>ibid</i>
Turn on call waiting	When call waiting is turned on	\$mac \$ip \$model

		\$firmware
Turn off call waiting	When call waiting is turned off	<i>ibid</i>
Using a headset	When using a headset	<i>ibid</i>
hands-free	hands-free	<i>ibid</i>
Cancel Outbound	When canceling an outgoing call	<i>ibid</i>
remotely busy	Remote call on busy	<i>ibid</i>
Cancel Remote Call	When canceling a remote call	<i>ibid</i>
Peripheral Information	When updating peripheral information	<i>ibid</i>
VPN IP	When the VPN obtains an IP	<i>ibid</i>

Description of variables

Variables supported in the Action URL:

Reportable actions	clarification
\$mac	Phone MAC address.
\$ip	Phone IP address.
\$model	Phone Type.
\$firmware	The firmware version number of the phone.
\$active_url	The sip_uri of the current active account (only in effect for inbound, outbound, and calls).
\$active_user	User account replenishment for the sip_uri of the currently active account (only in effect for inbound, outbound, and calls).
\$active_host	The server portion of the current active account's sip_uri (only in effect for inbound, outbound, and calls).
\$local	The local sip_uri.
\$remote	The sip_uri of the opposite end.
\$display_local	The local display name.
\$display_remote	The name of the opposite end of the display.
\$call_id	Call ID.
\$callerID	The display name of the caller on an outgoing call.
\$calledNumber	The number that is called out on an outgoing call.

Web Configuration Instructions

- Configuring Action URLs on Web Pages

1. Log in to the web user interface.
2. Click **Function (U)** -> **Action URL (6)**.
3. Enter the information to be reported to the server in the appropriate fields.

Example:

http(s)://server address/help.xml?mac=\$mac

4. Click the **Submit** button to save the changes.

Action URL	URL
Setup Completed	
Registered	
Unregistered	
Register Failed	
Off Hook	
On Hook	
Incoming Call	http://192.168.17.48/help.xml?mac=5mac
Outgoing Call	
Established	
Terminated	
Open DND	
Close DND	
Always Forward On	
Always Forward Off	
Busy Forward On	
Busy Forward Off	
No Answer Forward On	
No Answer Forward Off	
Transfer Call	
Blind Transfer	

Type of web access

You can configure the web access type to restrict web logins.

- Configuration of web access types through web pages

1. Log in to the web user interface.
2. Click Network Configuration (N) -> **Advanced (v)**.
3. Configure the type of network access click Net.
 - a) Enable/disable http access;
 - b) Configure the http access port, the default 80 access without adding the port other to add after the IP to access;
 - c) Enable/disable https access;
 - d) Configure the https access port, default 443 access without adding the port other to add after the IP to access;

Web Server	
HTTP	Enabled
HTTP Port (1~65535)	80
HTTPS	Enabled
HTTPS Port (1~65535)	443

4. Click Submit to save the configuration.

Pages cannot be accessed via web pages after disabling http and https, you can enable access via phone menu->Settings->Advanced Settings->Network->Network Access Type.

- Set the login password on the web page

1. Log in to the Web user interface.
2. Click Security (F) -> Password.
3. Enter the old password, new password, and confirm password.
4. Click Submit to confirm the operation or cancel the current operation.

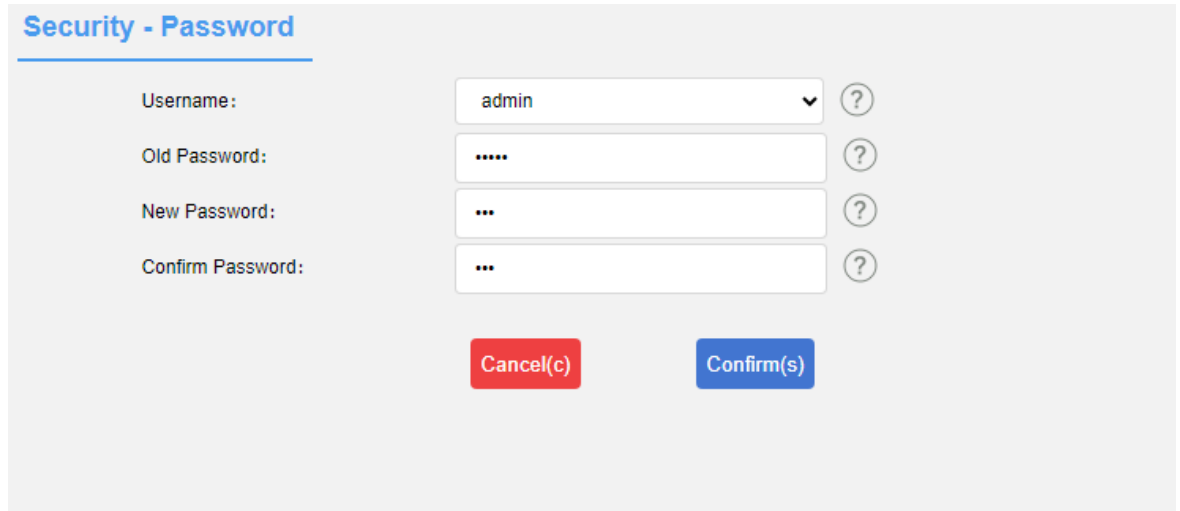

- Set the advanced password on the web page

1. Log in to the Web user interface.
2. Click Security (F) -> Advanced Password Settings.
3. Enter the old password, new password, and confirm password.
4. Click Submit to confirm the operation or cancel the current operation.

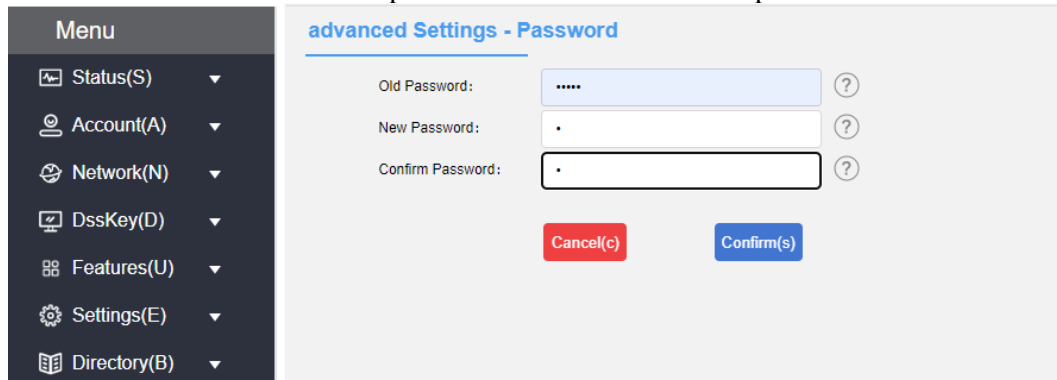

Note: The password is used in the phone menu -> Settings -> Advanced Settings. The default password is admin.

Trusted Certificates

You can upload specific CA certificates to your phone.

- **Configuration of trusted certificates via web page**

1. Log in to the web user interface.
2. Click **Security (F) -> Trusted Certificates (@)**.
3. Select the appropriate value from **Allow only trusted certificates, User name confirmation, CA certificates**.

4. Click **Submit** to confirm the operation.

A dialog box pops up, prompting for a reboot to take effect.

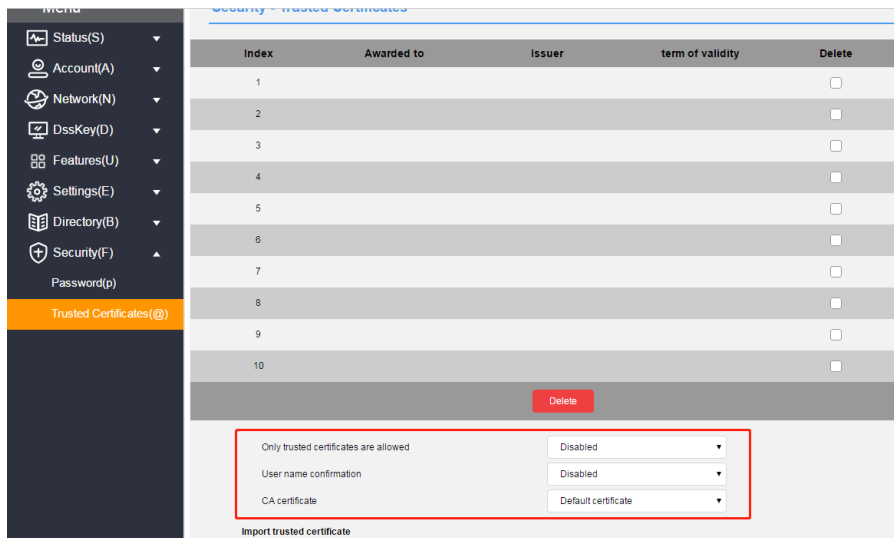

5. Click **Confirm** to restart the phone.

- Uploading trusted certificates via the web

1. Log in to the web user interface.
2. Click Security (F) -> Trusted Certificates (@).
3. Click **Browse** in the **Load Trusted Certificate File** area to select a local certificate file (*.pem, *.cert, *.cer or *.der).
4. Click **Import** to upload the certificate. **After the import is successful, a message is displayed indicating that the loading is successful. Refresh the page two seconds later.**

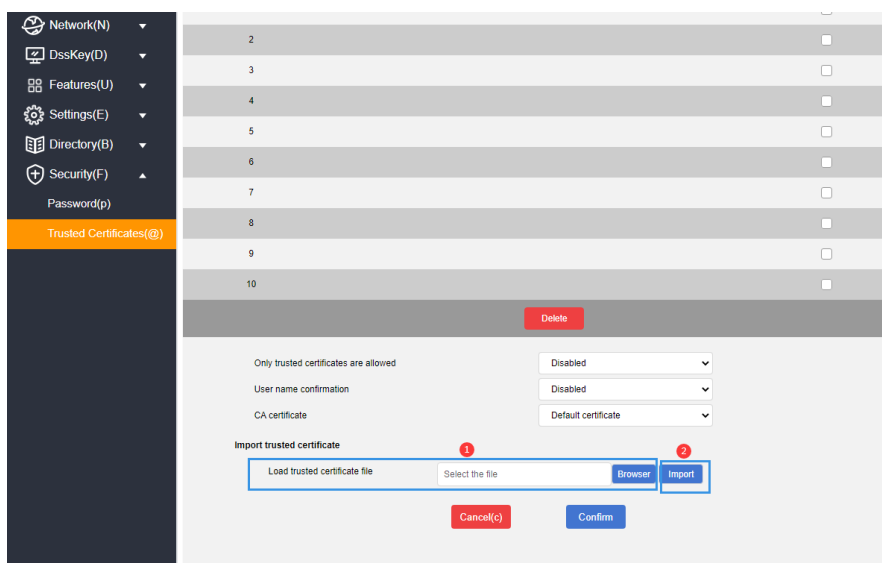

- View and delete certificates through web pages

1. Log in to the Web user interface.
2. Click Security (F) -> Trusted Certificates (@).
3. You can view in the list that the uploaded certificate contains information about the issue to , issuer and validity period;
4. You can also select an unnecessary certificate and click the **Delete** button at the bottom

to delete the certificate.

The screenshot shows a web interface with a dark sidebar menu on the left and a main content area on the right. The sidebar menu includes items like Status(S), Account(A), Network(N), DssKey(D), Features(U), Settings(E), Directory(B), Security(F), Password(p), advanced Settings password(A), and Trusted Certificates(@). The main content area is titled "Security - Trusted Certificates" and contains a table with the following data:

Index	Awarded to	Issuer	term of validity	Delete
1	CN	CN	Nov 22 09:30:20 2030 GMT	<input type="checkbox"/>
2				<input type="checkbox"/>
3				<input type="checkbox"/>
4				<input type="checkbox"/>
5				<input type="checkbox"/>
6				<input type="checkbox"/>
7				<input type="checkbox"/>
8				<input type="checkbox"/>
9				<input type="checkbox"/>
10				<input type="checkbox"/>

At the bottom of the table, there is a red arrow pointing to a red button labeled "Delete".